



# **Arab Academy for Science, Technology and Maritime Transport**

## **College of Engineering and Technology Department of Industrial and Management Engineering**

B. Sc. Final Year Project

### **Optimization of Traffic Signal Timings Using Genetic Algorithm, Simulation, and FPGA control**

Presented By:

*Ahmed Aziz Ezzat*  
*Mohamed El Ahmar*  
*Azmy Mehelba*

*Julia El Zoghby*  
*Nermine Hany*  
*Ezz Abou Emira*

Supervised By:

*Prof. Ahmed F. Abdel Moniem*  
*Prof. Khaled S. El-Kilany*  
*Dr. Hala A. Farouk*

J U L Y - 2 0 1 3

## DECLARATION

I hereby certify that this report, which I now submit for assessment on the programme of study leading to the award of Bachelor of Science in Industrial and Management Engineering, is all my own work and contains no Plagiarism. By submitting this report, I agree to the following terms:

*Any text, diagrams or other material copied from other sources (including, but not limited to, books, journals, and the internet) have been clearly acknowledged and cited followed by the reference number used; either in the text or in a footnote/endnote. The details of the used references that are listed at the end of the report are confirming to the referencing style dictated by the final year project template and are, to my knowledge, accurate and complete.*

I have read the sections on referencing and plagiarism in the final year project template. I understand that plagiarism can lead to a reduced or fail grade, in serious cases, for the Graduation Project course.

Student Name: Ahmed Aziz Ezzat  
Registration Number: 08102254

Signed: \_\_\_\_\_

Date: 23 – 06 – 2013  
Student Name: Nermine Hany  
Registration Number: 08102042

Signed: \_\_\_\_\_

Date: 23 – 06 – 2013

Student Name: Ezz Abou Emira  
Registration Number: 08100714

Signed: \_\_\_\_\_

Date: 23 – 06 – 2013

Student Name: Julia El Zoghby  
Registration Number: 08100357

Signed: \_\_\_\_\_

Date: 23 – 06 – 2013  
Student Name: Mohamed El Ahmar  
Registration Number: 08101591

Signed: \_\_\_\_\_

Date: 23 – 06 – 2013

Student Name: Azmy Mehelba  
Registration Number: 08102567

Signed: \_\_\_\_\_

Date: 23 – 06 – 2013

# STUDENTS CONTRIBUTION

## “Optimization of Traffic Signal Timings Using Genetic Algorithm, Simulation and FPGA Control”

By:

Ahmed Aziz Ezzat  
Julia El Zoghby  
Nermine Hany  
Mohamed El Ahmar  
Ezz Abou Emira  
Azmy Mehelba

Chapter	Title	Contributors
1	Introduction	All students
2	Literature Review	All students
3	Data Collection and Statistical Analysis	Julia El Zoghby Nermine Hany Mohamed El Ahmar Ahmed Aziz Ezzat Ezz Abou Emira
4	Analytical Modeling and Genetic Algorithm	Ahmed Aziz Ezzat
5	Simulation and Modeling of Actual system	Julia El Zoghby Nermine Hany Mohamed El Ahmar Ahmed Aziz Ezzat
6	Simulation of proposed scenario1 and 3D animation	Mohamed El Ahmar
7	Simulation of an adaptive traffic control system	Nermine Hany
8	Optimization using simulation approach	Julia El Zoghby
9	Hardware in Traffic control	Ezz Abou Emira
10	FPGA control in a pre-timed traffic system	Ahmed Aziz Ezzat
11	FPGA control in an adaptive traffic system	Azmy Mehelba
12	Conclusions and Recommendations	All students

## **ACKNOWLEDGMENT**

We have taken efforts in this project. However, it would have been impossible without the kind support and help of our organization.

We would like to express our sincere appreciation and deepest gratitude to Prof. Ahmed F. Abdel Moniem. This work could not have been completed without his valuable guidance and immense knowledge.

A special acknowledgement belongs to our dearest professor Khaled S. El-Kilany for his active cooperation and support during the period of this project. We deeply appreciate how he invests his full effort in guiding us and enlightening our way.

We are also indebted to Dr. Hala A. Farouk for her support during the preparation of this work. We have learned a lot and benefited a great deal by her critical comments and suggestions.

Finally, we would like to thank our families and friends for their encouragement and support throughout our lives.

## **ABSTRACT**

Traffic congestion is a major problem in vastly populated cities. This project focuses on the traffic crisis seen in Alexandria, which occurs due to the absence of a reliable control strategy that regulates the traffic signal lights. As a result, a substantial growth of the vehicles' queue lengths and delays emerges. The main aim of this project is to minimize the traffic congestion for a traffic control system, considering the traffic signal timings rendered to a number of control points in specified intersections. In order to satisfy this goal, a set of objectives to be carried out through the project are established.

The main objectives include developing an analytical model representing the traffic system and proposing a solution approach using the Genetic Algorithm technique. Furthermore, developing a simulation model for the problem in order to replicate and analyse the performance of the real system, as well as suggesting better scenarios to improve the overall system efficiency. Furthermore, a simulation model is developed to represent a smart traffic control system, and evaluate its correspondent performance compared to the current situation. In addition, employing optimization using simulation methodology to reach the best possible traffic light timings, and last but not least, studying the possibility of applying FPGA's for the control of traffic systems.

The report focuses on generating different scenarios and various solutions through experimenting with the developed models in order to optimize the traffic signal timings. Comparisons are held between different approaches and methodologies to achieve the best possible performance and cut off the traffic congestion problem from its root causes.

# TABLE OF CONTENTS

<b>LIST OF FIGURES.....</b>	<b>V</b>
<b>LIST OF TABLES.....</b>	<b>IX</b>
<b>LIST OF ACRONYMS/ABBREVIATIONS .....</b>	<b>XI</b>
<b>LIST OF SYMBOLS .....</b>	<b>XII</b>
<b>1 INTRODUCTION .....</b>	<b>1</b>
<b>1.1 Problem Statement .....</b>	<b>4</b>
<b>1.2 Aim and Objectives .....</b>	<b>5</b>
1.2.1 Aim.....	5
1.2.2 Objectives.....	5
<b>1.3 Report Outline .....</b>	<b>5</b>
<b>2 LITERATURE REVIEW .....</b>	<b>7</b>
<b>2.1 Overview and Background .....</b>	<b>8</b>
<b>2.2 Classification of references .....</b>	<b>8</b>
<b>2.3 Introduction to Analytical Modelling and Solution Approach.....</b>	<b>11</b>
2.3.1 Basic Concepts of Analytical Modelling.....	11
2.3.2 Steps of Analytical modelling .....	12
2.3.3 Solution Approaches .....	13
2.3.4 Related Work .....	16
<b>2.4 Simulation .....</b>	<b>17</b>
2.4.1 Basic Concepts of Modelling and Simulation .....	18
2.4.2 Simulation Steps.....	21
2.4.3 Previous Research on the Simulation of Traffic Light Signal Timing .....	23
2.4.4 Optimization using simulation .....	24
2.4.5 Previous Research on the Optimization using Simulation of Traffic Light Signal Timing	25
2.4.6 Commercial off- The- Shelf Software Packages COTS .....	26
<b>2.5 Hardware.....</b>	<b>29</b>
2.5.1 Traffic Control Devices: Uses and Applications .....	29
2.5.2 The Use of Traffic Hardware in Data Collection .....	30
2.5.3 Selection Criteria: The appropriate methodology/ traffic hardware .....	33
2.5.4 Related work .....	34
2.5.5 Data collection: Decisions.....	35
<b>3 DATA COLLECTION AND STATISTICAL ANALYSIS.....</b>	<b>37</b>
<b>3.1 Introduction to data collection .....</b>	<b>37</b>
<b>3.2 Data collection in traffic control.....</b>	<b>37</b>
3.2.1 Manual versus modern sensors.....	38
<b>3.3 Data collection plan .....</b>	<b>38</b>
<b>3.4 List of System parameters &amp; variables to be measured.....</b>	<b>39</b>

3.5	Sample size .....	41
3.6	Data collection methodology.....	42
3.7	Introduction to Statistical Analysis.....	43
3.8	Boxplots .....	43
3.8.1	Theory of operation:.....	44
3.9	Data fitting and analysis .....	46
3.9.1	Introduction to Statfit .....	46
3.9.2	Data fitting results .....	47
<b>4</b>	<b>ANALYTICAL MODELING AND SOLUTION USING GENETIC ALGORITHM APPROACH .....</b>	<b>50</b>
<b>4.1</b>	<b>Introduction .....</b>	<b>50</b>
<b>4.2</b>	<b>Analytical Modeling .....</b>	<b>51</b>
4.2.1	Problem Statement .....	51
4.2.2	System Description and Problem Layout.....	52
4.2.3	Enumeration of Problem Decision Variables .....	57
4.2.4	Enumeration of system parameters .....	60
4.2.5	Enumeration of the Response variables .....	60
4.2.6	Proposed Objective Function(s).....	62
4.2.7	Enumeration of Governing Constraints.....	64
4.2.8	Proposed Solution Approaches .....	66
<b>4.3</b>	<b>Proposed solution approach: Genetic Algorithm .....</b>	<b>66</b>
4.3.1	Introduction to Genetic Algorithms .....	66
4.3.2	Solution approach structure: Optimization of traffic signal timings using Genetic Algorithm .....	68
<b>4.4</b>	<b>Extendsim8 Simulation of G.A optimized timings .....</b>	<b>87</b>
<b>4.5</b>	<b>Conclusions &amp; Recommendations.....</b>	<b>87</b>
<b>5</b>	<b>MODELING AND SIMULATION OF THE ACTUAL SYSTEM .....</b>	<b>91</b>
<b>5.1</b>	<b>Introduction to computer simulation.....</b>	<b>91</b>
<b>5.2</b>	<b>ExtendSim 8: Simulation Software package .....</b>	<b>92</b>
<b>5.3</b>	<b>Review on Simulation steps .....</b>	<b>92</b>
5.3.1	Step 1: Problem formulation .....	94
5.3.2	Step 2: Modelling.....	95
5.3.3	Step 3: Data collection and analysis.....	97
5.3.4	Step 4: Model translation .....	100
5.3.5	Step 5: Verification and Validation.....	107
5.3.6	Step 6: Experimentation & Results .....	109
<b>5.4</b>	<b>Conclusions .....</b>	<b>109</b>
<b>6</b>	<b>SIMULATION SCENARIO1: PROPOSED SOLUTION &amp; 3D ANIMATION USING EXTENDSIM .....</b>	<b>110</b>
<b>6.1</b>	<b>scenario1 versus actual model .....</b>	<b>110</b>
6.1.1	The Actual model.....	110
6.1.2	The proposed solution " Scenario1 " .....	111
<b>6.2</b>	<b>Model Translation of Scenario1 .....</b>	<b>113</b>
6.2.1	Intersection 1 .....	113
6.2.2	Intersection 2:.....	115

<b>6.3</b>	<b>Simulation Experimentation.....</b>	<b>116</b>
6.3.1	Runing the model .....	116
<b>6.4</b>	<b>Results and analysis.....</b>	<b>117</b>
6.4.1	Scenario1 versus the actual model .....	117
6.4.2	Percentage improvement calculation.....	118
6.4.3	Overall percentage improvement .....	120
<b>6.5</b>	<b>3D animation in simulation.....</b>	<b>120</b>
6.5.1	Introduction to Extendsim8 animation .....	120
6.5.2	3D animation of intersection (1) .....	121
<b>6.6</b>	<b>Conclusion and Recommendations .....</b>	<b>122</b>
<b>7</b>	<b>SIMULATION OF AN ADAPTIVE TRAFFIC CONTROL SYSTEM.....</b>	<b>123</b>
<b>7.1</b>	<b>Introduction .....</b>	<b>123</b>
<b>7.2</b>	<b>History of Adaptive Traffic Systems.....</b>	<b>123</b>
<b>7.3</b>	<b>Adaptive Control Systems: Theory of Operation .....</b>	<b>124</b>
<b>7.4</b>	<b>Model Translation .....</b>	<b>124</b>
<b>7.5</b>	<b>Simulation Experimentation.....</b>	<b>128</b>
<b>7.6</b>	<b>The Adaptive Model Versus the Actual Model.....</b>	<b>129</b>
<b>7.7</b>	<b>Conclussions and Recommendations.....</b>	<b>132</b>
<b>8</b>	<b>EXTENDSIM OPTIMIZATION USING SIMULATION.....</b>	<b>134</b>
<b>8.1</b>	<b>Introduction .....</b>	<b>134</b>
<b>8.2</b>	<b>Optimization &amp; Simulation optimization .....</b>	<b>135</b>
8.2.1	Simulation optimization .....	136
8.2.2	Simulation optimization using ExtendSim .....	136
8.2.3	The ExtendSim Optimizer.....	137
8.2.4	Theory of the ExtendSim8 optimizer .....	137
<b>8.3</b>	<b>Model Formulation.....</b>	<b>138</b>
8.3.1	Problem Decision Variables .....	138
8.3.2	System parameters .....	140
8.3.3	System Response variables .....	141
8.3.4	Objective Function .....	141
8.3.5	The system's Constraints .....	142
<b>8.4</b>	<b>Model translation.....</b>	<b>143</b>
<b>8.5</b>	<b>Optimization of the actual and proposed model.....</b>	<b>145</b>
8.5.1	The steps for optimizing the traffic light signals .....	145
<b>8.6</b>	<b>EXPERIMENTATION AND RESULTS .....</b>	<b>157</b>
8.6.1	Optimization of the traffic light signals for the actual model.....	157
8.6.2	Optimization of the traffic light signal's results for the proposed solution (scenario 1).....	162
8.6.3	Comparing the optimization results for the actual model and scenario 1 .....	168
8.6.4	Overall percentage improvement .....	169
<b>8.7</b>	<b>CONCLUSIONS AND RECOMMENDATIONS .....</b>	<b>170</b>
<b>9</b>	<b>HARDWARE IN TRAFFIC CONTROL.....</b>	<b>172</b>
<b>9.1</b>	<b>Introduction to hardware in traffic control .....</b>	<b>172</b>
<b>9.2</b>	<b>Traffic control sensors .....</b>	<b>173</b>
9.2.1	Modern sensors .....	173



9.2.2	Selection Criteria: The appropriate methodology/ traffic hardware .....	174
<b>9.3</b>	<b>Traffic control using FPGA's:.....</b>	<b>175</b>
<b>10</b>	<b>FPGA CONTROL IN A PRE-TIMED SYSTEM.....</b>	<b>176</b>
<b>10.1</b>	<b>Introduction .....</b>	<b>176</b>
<b>10.2</b>	<b>The pre-timed traffic control system: Theory of operation.....</b>	<b>177</b>
<b>10.3</b>	<b>The hardware design of the pre-timed traffic control system .....</b>	<b>178</b>
<b>10.4</b>	<b>FPGA Synthesis and Implementation.....</b>	<b>183</b>
<b>10.5</b>	<b>Prototyping.....</b>	<b>185</b>
<b>10.6</b>	<b>Conclusions .....</b>	<b>187</b>
<b>11</b>	<b>FPGA CONTROL IN AN ADAPTIVE TRAFFIC SYSTEM.....</b>	<b>188</b>
<b>11.1</b>	<b>Introduction to FPGA's .....</b>	<b>188</b>
<b>11.2</b>	<b>The Design of a FPGA-Based adaptive Traffic Control System: theory of operation.....</b>	<b>189</b>
<b>11.3</b>	<b>FPGA'S: advantages vs. limitations.....</b>	<b>190</b>
<b>11.4</b>	<b>Conclusions .....</b>	<b>190</b>
<b>12</b>	<b>CONCLUSIONS AND RECOMMENDATIONS.....</b>	<b>191</b>
	<b>REFERENCES .....</b>	<b>196</b>
	<b>APPENDICES .....</b>	<b>200</b>
	<b>APPENDIX (A): GA CODING USING VBA.....</b>	<b>201</b>
	<b>APPENDIX (B): EXTENDSIM8 BLOCKS AND LIBRARIES .....</b>	<b>209</b>
	<b>APPENDIX (C): DATA COLLECTION POINTS AND OBSERVATIONS .....</b>	<b>211</b>

# LIST OF FIGURES

Figure 2-1: Classification of References According to Years .....	10
Figure 2-2: Classification of References According to Source.....	10
Figure 2-3: Classification of References According to Topic .....	11
Figure 2-4: Steps of analytical modeling .....	13
Figure 2-5: Cross-over process .....	15
Figure 2-6: Mutation process .....	15
Figure 2-7: Steps of GA study. ....	16
Figure 2-8: Components of a system. ....	19
Figure 2-9: Representation of a system.....	20
Figure 2-10: Classification of simulation models. ....	21
Figure 2-11: Steps in a simulation study.....	22
Figure 2-12: Simulation optimization process. ....	24
Figure 2-13: Illustration of optimum vs. local optima .....	25
Figure 2-14: TRANSYT software.....	27
Figure 2-15: Sim Traffic8 .....	27
Figure 2-16: Road tube .....	31
Figure 2-17: Representation of an inductive loop sensor.....	32
Figure 2-18: Ultrasonic detectors.....	32
Figure 2-19: Microwave radar detector .....	33
Figure 2-20: Video image processing technologies VIP.....	33
Figure 3-1: measurement positions in a road network .....	43
Figure 3-2: Boxplot.....	44
Figure 3-3: boxplot output displayed on excel sheet .....	46
Figure 4-1: Layout of one of Alexandria’s road networks.....	53
Figure 4-2: road network with control points defined.....	54
Figure 4-3: layout of intersection 1 .....	55
Figure 4-4: Layout of intersection (2).....	55
Figure 4-5: Cross-over process .....	67
Figure 4-6: Mutation process .....	67
Figure 4-7: G.A. steps.....	68
Figure 4-8: Layout of Intersection (1).....	69
Figure 4-10: Layout of intersection (2).....	70
Figure 4-11: Chromosome structure in G.A experiment .....	72
Figure 4-12: Main flowchart of the GA VBA code .....	73

Figure 4-13: Chromosome formation procedure in the GA code .....	74
Figure 4-14: Queuing procedure in the GA code.....	75
Figure 4-15: Reproduction procedure in the G.A code.....	76
Figure 4-16: Data Enter procedure.....	77
Figure 4-17: Vehicles' simulation in G.A. code .....	78
Figure 4-18: Specification of G.A parameters in G.A code.....	78
Figure 4-19: Chromosome formation in G.A code .....	78
Figure 4-20: Queuing in G.A code.....	79
Figure 4-21: Queuing (2) in G.A. code .....	80
Figure 4-22: Queuing (3) in G.A. code .....	80
Figure 4-23: Fitness function calculation.....	81
Figure 4-24: Fitness function calculation (2).....	82
Figure 4-25: Generation sorting in G.A code .....	82
Figure 4-26: Selection in G.A code .....	83
Figure 4-27: Crossover in G.A code .....	84
Figure 4-28: Copying in G.A code.....	84
Figure 4-29: Printing results in G.A code .....	85
Figure 4-30: Printing results in G.A code (2) .....	85
Figure 4-31: Chart comparing the actual vs. G.A model in terms of LQav .....	88
Figure 4-32: Chart comparing the actual vs. GA model in terms of WQav .....	88
Figure 4-33: Chart comparing the actual vs. GA model in terms of LQav * WQav .....	89
Figure 5-1: Simulation Steps .....	94
Figure 5-2: Layout of the road network under study in simulation experimentation .....	98
Figure 5-3: State diagram of intersection (1) .....	99
Figure 5-4: State diagram of intersection (2) .....	99
Figure 5-5: Vehicular arrivals in simulation of actual model .....	100
Figure 5-6: Queuing in simulation of actual model .....	101
Figure 5-7: Signalization in simulation of actual model.....	101
Figure 5-8: Inter-delay time in simulation of actual model .....	102
Figure 5-9: Exiting the intersection in simulation of actual model.....	102
Figure 5-10: Layout of actual system in simulation of actual model.....	103
Figure 5-11: Part of the simulation of actual model .....	104
Figure 5-12: Equation block in simulation of actual model.....	105
Figure 5-13: Value lookup table in simulation of actual model.....	105
Figure 5-14: Vehicular arrivals in intersection (1) in simulation of actual model.....	107
Figure 5-15: vehicular arrivals to CP(2) in intersection (1) in actual model .....	107
Figure 6-1: changes to actual system .....	110

Figure 6-2: CP (4) added to scenario1 in simulation experimentation .....	111
Figure 6-3: Intersection layout in simulation of scenario 1 .....	112
Figure 6-4: Portsaid branch of intersection (1) in simulation of scenario1 .....	114
Figure 6-5: Tram to corniche branch in simulation of scenario 1 .....	114
Figure 6-6: Intersection (2) in simulation of scenario 1 .....	115
Figure 6-7: Modeling of intersection (2) in simulation of scenario 1 .....	116
Figure 6-8: Actual vs. Scenario 1 in terms of LQav .....	119
Figure 6-9: Actual vs. Scenario1 in terms of WQav .....	119
Figure 6-10: Actual vs. Scenario1 in terms of (LQav * WQav) .....	120
Figure 6-11: 2D model used to generate 3D animation of intersection (1).....	121
Figure 6-12: 3D animation of intersection (1) .....	121
Figure 8-1: Theory of operation of adaptive traffic control systems .....	124
Figure 7-2: Equation block used to calculate the adapted signal timing in ATCs modeling .....	125
Figure 7-3: Equation used to calculate adapted signal timing in ATCs modeling.....	126
Figure 7-4: input variables to the equation block in ATCs simulation modeling .....	126
Figure 7-5: signalization process in ATC's simulation modeling .....	127
Figure 7-6: ATC simulation modeling of intersection (1) .....	127
Figure 7-7: verification of system metrics in ATCs modeling .....	128
Figure 7-8: Results shown on excel sheets of ATCs modeling.....	129
Figure 7-9: Results (2) shown on excel sheets of ATCs modeling.....	129
Figure 7-10: Actual vs. adaptive model in terms of LQav.....	131
Figure 7-11: actual vs. adaptive model in terms of WQav .....	131
Figure 7-12: Actual vs. adaptive model in terms of (LQav * WQav).....	132
Figure 8-1: Calculation of CTbest in optimization using simulation.....	147
Figure 8-2: Layout of the intersection under study in optimization using simulation .....	149
Figure 8-3: The objective function of the optimization using simulation model.....	152
Figure 8-4: Constraints within the optimizer block in optimization using simulation model....	154
Figure 8-5: run parameters in the optimization using simulation model .....	155
Figure 8-6: results found in the optimizer block in optimization using simulation model .....	156
Figure 8-6: Actual vs. optimized scenario 1 in terms of LQav .....	166
Figure 8-7: Actual vs. optimized scenario1 in terms of WQav.....	167
Figure 8-8: Actual vs. optimized scenario1 in terms of (LQav * WQav).....	167
Figure 8-9: Actual vs. optimized scenario 1 in terms of TSav.....	168
Figure 8-10: optimized actual vs. optimized scenario 1 in terms of TSav .....	169
Figure 10-1: intersection (1) layout where the FPGA control will take place .....	177
Figure 10-2: state diagram of the intersection under study in FPGA control .....	179
Figure 10-3: ASM of FPGA design to control a pre-timed system .....	180

Figure 10-4: Countdown procedure in an FPGA design to control a pre-timed system.....	181
Figure 10-5: Design Synthesis .....	184
Figure 10-6: Routing and placing .....	185
Figure 10-7: Theory of operation of the prototype of FPGA controlling a traffic system.....	186
Figure 10-8: The prototype representing FPGA control in a pre-timed traffic control system..	187
Figure 12-1: Actual system vs. all the proposed solutions in terms of $LQ_{av}$ .....	193
Figure 12-2: Actual system vs. all the proposed solutions in terms of $WQ_{av}$ .....	193
Figure 12-3: Actual vs. all proposed solutions in terms of $(LQ_{av} * WQ_{av})$ .....	194
Figure 12-4: Actual system vs. adaptive model in terms of $(LQ_{av}*WQ_{av})$ .....	194

## LIST OF TABLES

Table 2-1: Classification of references. ....	9
Table 3-1: day classification into periods .....	39
Table 3-2: average proportions for left/right turns.....	47
Table 3-3: road capacities for control points .....	47
Table 3-4: percentage time lost in signal timing.....	47
Table 3-5: Random distributions for arrivals .....	48
Table 4-1: Periods of the day .....	53
Table 4-2: Phase plan of intersection (1) .....	55
Table 4-3: Actual Phase plan of intersection (2).....	56
Table 4-4: Proposed phase plan of intersection (2).....	56
Table 4-5: General phase plan of a road network .....	57
Table 4-6: Phase plan used for signal timing calculation .....	59
Table 4-7: Phase plan of intersection (1) .....	69
Table 4-8: Proposed Phase plan of intersection (2) .....	70
Table 4-9: G.A results.....	86
Table 4-10: red and green signals based on G.A optimized timings.....	86
Table 4-11: Simulation results of G.A. optimized timings .....	87
Table 5-1: Actual Phase plan of intersection (1).....	98
Table 5-2: Actual phase plan of intersection (2).....	99
Table 5-3: Actual model phase plan in simulation of actual model.....	104
Table 5-4: Results of the simulation of the actual model.....	109
Table 6-1: configuration of intersection (1) in simulation of scenario1 .....	112
Table 6-2: configuration of intersection (2) in simulation of scenario1 .....	112
Table 6-3: Modified phase plan of intersection (2) in simulation of scenario1 .....	113
Table 6-4: Results of simulation of scenario1 .....	117
Table 6-5: Comparison of scenario1 versus actual model in terms of LQav .....	117
Table 6-6: Comparison of scenario1 vs. Actual model in terms of WQav .....	118
Table 6-7: Comparison of scenario1 vs. Actual model in terms of LQav*WQav .....	118
Table 6-8: Percentage improvement values in different periods of the day for scenario1.....	119
Table 6-9: Signal timings for scenario (1) .....	122
Table 7-1: Values of percentage improvement of ATCs through all periods of the day .....	130
Table 8-1: State timings obtained in optimization of actual model .....	158
Table 8-2: State timings obtained in optimization of actual model .....	159
Table 8-3: red and green timings obtained through optimization of actual model .....	159

Table 8-4: performance metrics from the optimization using simulation of actual model .....	160
Table 8-5: performance metrics (2) from optimization using simulation of actual model .....	160
Table 8-6: Improvement percentages obtained.....	161
Table 8-7: Results of optimization using simulation of scenario 1 .....	163
Table 8-8: State timings obtained through optimization using simulation of scenario 1 .....	163
Table 8-9: Signal timings obtained through optimization using simulation of scenario 1.....	164
Table 8-10: performance metrics for optimization using simulation of scenario 1 .....	164
Table 8-11: performance metrics (2) of optimization using simulation of scenario 1 .....	165
Table 8-12: Values of percentage improvement in optimized scenario 1 .....	165
Table 10-1: phase plan of intersection under study in FPGA control.....	178
Table 10-2: design signals correspondent to signal timings in FPGA design.....	182

## **LIST OF ACRONYMS/ABBREVIATIONS**

<b>Acronym</b>	<b>Definition of acronym</b>
GA	Genetic Algorithm
FPGA	Field Programmable Gates Arrays
AC	Ant Colony technique
COTS	Commercial Off - The- Shelf Software Packages
MF	Mathematical Formulation
S	Simulation
SO	Optimization using simulation
GIGO	Garbage in, garbage out
VIP	Video image processing technologies
CP	Control Point
TG	Green timing interval for a control point
TR	Red timing interval for a control point
IQR	The inter-quartile range
CT	Cycle time of the intersection
VBA	Visual Basic Applications
FF	Fitness Function
ATCS	Adaptive traffic control system
SCATS	Sydney Coordinated Adaptive Traffic System
SCOOT	Split Cycle Offset Optimization Technique
FHWA	Federal Highway Administration
OPAC	Online Public Access catalogue
ACS lite	Adaptive Control Software Lite



## LIST OF SYMBOLS

<b>Symbol</b>	<b>Description</b>
$\lambda_j$	Arrival rate at control point j.
$\mu_j$	Departure rate at control point j.
$V_{secondary_j}$	Left or right turn volumes at control point j.
$T_L$	Lost time interval in a signal timing.
$L_j$	Maximum capacity of control point j.
Q1	The 1st quartile in a sample.
$X_{min}$	The minimum value of the sample in boxplot analysis.
$X_{max}$	The maximum value of the sample in boxplot analysis.
$CT_k$	Cycle time of an intersection (k).
$TG_j$	Green signal timing interval of control point (j).
$TR_j$	Red signal timing interval of control point (j).
M	Number of control points in an intersection.
L	Maximum vehicular capacity of control points in an intersection.
LQ	Queue length forming at a control point in an intersection.
WQ	Vehicular Waiting time forming at a control point in an intersection.
$LQ_{max}$	Maximum Queue length forming at a control point in an intersection.
$WQ_{max}$	Maximum Waiting time at a control point in an intersection.
$LQ_{av}$	Average Queue length forming at a control point in an intersection.
$WQ_{av}$	Average Waiting time at a control point in an intersection.
F	The safety factor to keep performance metrics within limits.
$P_a$	Proportion of State (A) from the intersection's cycle time.
$P_b$	Proportion of State (B) from the intersection's cycle time.
$P_c$	Proportion of State (C) from the intersection's cycle time.
$z_n$	Fitness Function of chromosome (n).
$n$	The chromosome's index from (1) to population size.
$\overline{TS}_j$	Actual average time spent in the system.
$\overline{TS}^*_j$	Best average time spent in the system.

## *Chapter One*

### **1 INTRODUCTION**

Traffic congestion has become a great challenge and a large burden on both the governments and the citizens all over the world. Traffic congestion, originally initiated by several factors, will always continue to threaten the stability of the modern cities and the livelihood of its habitants. Analysing the roots of the problem will lead us to different factors. Above all, we currently live in a rapidly developing world. The modern cities have become more populated than ever, whether by high birth rates and populations' growth or by migration. In addition, the technological advancements and the race of competitiveness in the world market arising from globalization effects, have paved the way for nearly every citizen to possess a vehicle. As a result, the utilization of the cities' road network exceeds its planned capacity, leading to a crushing inflation in the numbers of vehicles waiting to be served in line. Massive queues build up, waiting times increase drastically, and the accident's risk is doubled. The negative consequences can also include the psychological effect on the drivers that have waited a considerable amount of time in queue, which is negatively reflected on their behaviour. The overall productivity is affected, as the working force may never reach its destination at the right time. The environmental effect also represents another aspect of the problem due to the high rates of fuel consumption, energy losses, toxic exhausts and gas emissions.

However, the problem has been addressed by many researchers since the early fifties of the past century. The literature review chapter of this report sheds light on a large number of models, proposed methodologies and case studies presented by the researchers and analysts all over the world to model the traffic system, analyse and improve its performance, and cut off the congestion problem from its root causes. The report illustrates the great importance of this critical problem through a sequential and smooth presentation of these researches. A quick glance to further sections of the report will show that a large proportion of the researches and case studies reviewed have been carried out and published in the past couple of years. This has only one signification; Traffic congestion problem is a very hot topic addressed by a large section of the researchers and engineers in today's world.

To be more specific, different mechanisms and methodologies could be carried out to combat the problem. The proposed solutions can be generally classified into two broad categories. The first category focuses on improving the geometrical design of the roads network. However, capacity expansion is not always possible. Therefore, on the other hand, the emphasis is on the improvement of the traffic control strategies that regulate the traffic flow.

Unfortunately, most of the developing countries might have failed in the first place to plan the design and the infrastructure of its road network. The main reason is that they did not accurately estimate the future inflation in the numbers of vehicles that have occurred nowadays, destroying the equilibrium that must exist between the roads capacity and the correspondent demand. Improving the geometric design of these roads is often infeasible, as many residential areas and buildings have been founded on the sides of the roads. Nevertheless, it is never too late. Improving the control policies that govern the traffic operations is a powerful solution that can overcome the arising traffic congestion. These improvements can be mainly carried out by enhancing the traffic control performance through adjusting the traffic light signal timings.

This project focuses on finding various solutions and methodologies for the optimization of traffic signal timings. Based on the review of the researches, textbooks and technical papers concerning the optimization of traffic signal timing, the project adopts and creates the approaches and techniques that have proved its effectiveness in curing the problem.

First, an analytical model is developed to accurately represent the traffic control system. Genetic Algorithm, a revolution in the world of meta-heuristic techniques, is a proposed approach to solve the model and return the optimum or near optimum set of signal timings. Then, as more complexity is added to the model, a new methodology is proposed. Simulation modelling and optimization using simulation are strongly recommended in this context to attain better scenarios and solutions. Finally, more emphasis on the technological advancements in sensing devices and intelligent traffic control systems through FPGA control is presented.

However, to pursue with this project, the reader must know some basic terminology and concepts to fully understand the problem, the solutions and the conclusions of this

project. As an adequate and logical start, the institute of transportation engineers defines traffic engineering as follows: “Traffic engineering is the phase of transportation engineering which deals with the planning, geometric design and traffic operations of roads, streets, and high-ways” [1].

Traffic flow can be classified into two principal categories: interrupted and un-interrupted flow. Un-interrupted flow exists on high ways and some rural roads where there are no intersections and stopping signals. Interrupted flow represents the flow inside the cities, where the movement is continuously regulated and stopped by signalization.

Moving to signalization process, some key definitions and terms must be presented. A signal cycle is the total time to complete one full cycle of signal indications around an intersection. Normally, every control point receives one green indication during each cycle. The cycle length is referred as “CT”.

A signal interval is the smallest unit of time within a signal cycle. Examples are the green timing intervals “TG” and the red timing intervals “TR” rendered to a specified control point.

A cycle split is the proportion of a specified interval to the total cycle time. For example a green split in a simple two-way intersection represents the green timing interval divided by the total cycle time “TG/CT”

Signals’ offset is the difference of the beginnings of the green phase between two adjacent intersections. This term is widely used in researches striving for synchronization and green waves.

A phase plan in traffic control determines the number of phases and control points that need to be signalized. The process must be done considering the demand of each control point, the geometrical design of the intersection and the accidents’ hazard.

Traffic control systems are classified mainly into two categories: pre-timed (fixed cycle) traffic control system, and adaptive (actuated) traffic control system. In the pre-timed traffic control system, the cycle length, the phase sequence and the signal interval timings are constant. Each period of the day characterized by an average demand, is

given a different pre-timed constant plan. On the other hand, the adaptive traffic control system is state-dependent. It can instantly adjust the timing intervals rendered to a specified control point according to the fluctuating demand crossing that point. Data about the demand is collected using modern sensing devices, sent to a controller which translates these data to a set of correspondent signal timing settings. Most of the developed countries applying the adaptive traffic control system have already implemented the pre-timed system in earlier stages.

Last but not least, there are many performance measures of a traffic system, which are used to analyse, evaluate and improve these systems. Such measures include the total and average delay (waiting times), the queue lengths, the throughput, the number of stops, the fuel consumption and energy waste, the roads' utilization, etc... In addition, each control point in a certain junction is characterized by a set of parameters. These parameters include the arrival rates and the dissipation rates.

As stated earlier, the literature review of this report presents a summary of a wide range of researches and papers that have addressed the problem. The chapter states the basic models and passes through the latest proposed solutions using modern techniques to improve the performance of complex traffic systems. Based on the information reviewed, a set of proposed methodologies and solutions are to be adopted throughout the course of this project in order to minimize the traffic congestion and optimize the traffic signal timings of the electronic traffic lights in Alexandria, Egypt.

## **1.1 PROBLEM STATEMENT**

Traffic congestion is a major problem in highly populated cities such as Alexandria. Due to the absence of a reliable control policy that regulates the traffic signal lights, a massive inflation of the vehicles' queue lengths and waiting times occurs. Through field observation, the signal light timings were found to be fixed through all the periods of the day, which does not correspond to the randomness of the time-fluctuating demand of vehicles.

## **1.2 AIM AND OBJECTIVES**

### **1.2.1 Aim**

The project's aim is to minimize the traffic congestion for a traffic control system, through the optimization of traffic signal timings rendered to a number of control points in specified intersections in Alexandria, Egypt.

### **1.2.2 Objectives**

The objectives of this work are as follows:

- Developing an analytical model that represents the traffic control system.
- Optimization of traffic light timings using Genetic Algorithm technique.
- Developing a simulation model that replicates the actual system in order to analyse the current system performance.
- Developing better simulation scenarios to improve the performance of the system.
- Optimization of traffic light timings using simulation based on the traffic performance metrics.
- Developing a simulation model that represents the application of an adaptive traffic control system.
- The possibility of applying Field programmable Gates Arrays "FPGA" to automate traffic control systems.

## **1.3 REPORT OUTLINE**

The report contents are as follows:

Chapter 2 is the literature review and presents the work related to the project.

Chapter 3 is the data collection and statistical analysis of data.

Chapter 4 presents the analytical model and Genetic Algorithm solution approach.

Chapter 5 is devoted to the simulation of the actual model.

Chapter 6 is concerned with the simulation of scenario1 and 3D animation.

Chapter 7 devotes itself to the simulation of an adaptive traffic control system.

Chapter 8 deals with the optimization using simulation for the traffic system.

Chapter 9 is an introduction to hardware in traffic control systems.

Chapter 10 discusses the application of FPGA control in a pre-timed traffic system.

Chapter 11 concerns itself to the application of FPGA control in an adaptive traffic system.

Chapter 12 states the main conclusions and recommendations of this report.

## *Chapter Two*

### **2 LITERATURE REVIEW**

As science is an evolutionary process, a researcher never begins from scratch. Newton was once quoted saying “If I have seen further, it is by standing on the shoulders of the giants.”

This chapter is the output of evaluating a large number of researches and papers concerning the proposed problem. These papers have been reviewed in order to enrich the background required to solve the proposed problem. The chapter consists of several sections as follows:

- The first section presents a general table that clarifies and compares the different methodologies and techniques adopted world widely by researchers and engineers to handle the proposed problem.
- The second section discusses generally the development of analytical models and Genetic Algorithms.
- The third section gives an introduction explaining the main definitions of simulation, the steps followed to conduct a successful simulation study, the use of optimization using simulation and the traffic control simulation software packages.
- The last section focuses on the modern hardware devices and sensing technologies used in traffic control, the selection criteria of the appropriate traffic sensors and the decisions taken based on this research.

Each section includes a correspondent summary to the related work and researches that have been reviewed intensively during the work on this project.



## 2.1 OVERVIEW AND BACKGROUND

During the last decades, traffic congestion has become a major problem that threatens the stability of modern cities and urban areas. As stated earlier, the problem may have devastating consequences such as queuing problems, inflation in waiting times, psychological effects, accidents risk and necking the overall livelihood of citizens. However, according to the famous newton's third law which states that every force has a reaction that is equal in magnitude and opposite in direction, traffic engineering -on the other hand- has witnessed a revolution in the solutions it offers, and the decision models it can establish to face the congestion problem and improve the overall performance of the traffic system.

## 2.2 CLASSIFICATION OF REFERENCES

A clear indication of the criticality and the importance of the problem is the infinite number of researches, technical papers and textbooks, addressing the problem and suggesting different solution approaches. Another indication is that the majority of the references that have been found and reviewed during the work on this project are published in the last decade, especially in the last couple of years. This has a clear signification that traffic engineering in general, and the optimization of traffic signal timing in particular is classified as a very hot topic for research all over the world.

The references that have been reviewed are either **general** or **specific**. The general references give a general overview about the problem or the techniques. While specific references discuss a specific case study or a successful experiment conducted in a certain location.

### **Classification of specific references (case studies)**

Table 2-1: classifies the case studies and experiments that have been reviewed based on their location, their issue date, the technique used and the specified objectives. The table excludes the general references such as textbooks, introductory tutorials, etc... The latter types of references appear in the statistical pie charts presented right after the table.

**Table 2-1: Classification of references.**

No.	Year	Case Study location	Proposed Methodologies <sup>1</sup>					Objectives			
			MF	GA	S	SO	Others	Min. of vehicle delay	Min. of Queue length	Synchronization	Others
1	1971		•		•			•			
2	1985				•			•		•	
3	1985	Texas, USA			•			•		•	
4	1986					•		•			
5	1995	NY, USA			•			•			
6	1998						•				•
7	1999			•				•		•	
8	2000	California, USA			•						•
9	2002				•				•	•	
10	2003				•			•	•		
11	2004				•			•			
12	2004	Colombo, Srilanka				•		•			•
13	2004	Nanjing, China	•		•			•			•
14	2005		•								•
15	2006					•	•				•
16	2006	Brussels			•					•	•
17	2006	Bari, Italy	•			•			•		
18	2006					•			•		
19	2008				•				•		
20	2008				•			•			•
21	2009			•		•		•			
22	2009		•	•							•
23	2009			•	•			•			
24	2010		•		•						•
25	2010	Nairobi, Kenya			•			•	•		•
26	2011			•				•			
27	2011		•				•				•
28	2011				•			•			•
29	2011	Nigeria			•			•			
30	2012						•				•
31	2012		•					•			•
32	2012		•	•				•	•		•
33	2011			•				•			
34	2012		•		•			•			•
35	2012	Jinan, China	•	•				•			
<b>Total</b>			<b>11</b>	<b>8</b>	<b>18</b>	<b>6</b>	<b>6</b>	<b>21</b>	<b>7</b>	<b>5</b>	<b>17</b>

<sup>1</sup> MF: Mathematical Formulation; GA: Genetic Algorithm; S: Simulation; SO: Simulation using Optimization

## Classification of general references

The following pie charts classify all the references that have been reviewed intensively during the work on this project. Figure 2-1 classifies the references according to their issue date. It indicates the criticality and importance of the topic nowadays. Figure 2-2 classifies the references according to their source such as journal articles, conference papers, textbooks, etc... Figure 2-3 classifies the references according to which section they cover in the report.

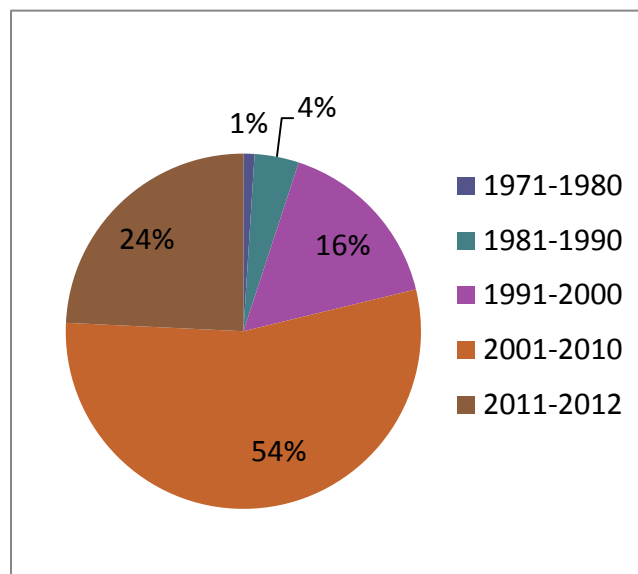

Figure 2-1: Classification of References According to Years

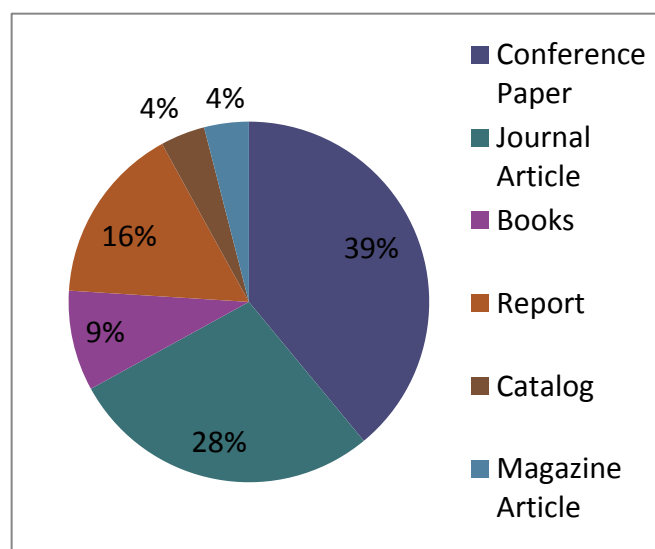
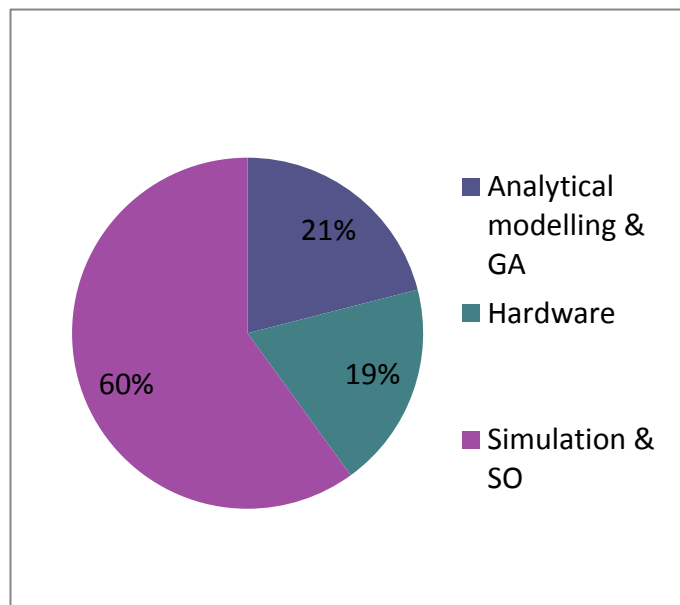

Figure 2-2: Classification of References According to Source



**Figure 2-3: Classification of References According to Topic**

## **2.3 INTRODUCTION TO ANALYTICAL MODELLING AND SOLUTION APPROACH**

### **2.3.1 Basic Concepts of Analytical Modelling**

Analytical modelling is a powerful tool used by engineers and analysts to describe the traffic control system. A large number of these models are solved using different solution techniques, in order to improve the traffic performance measures through the optimization of traffic signal timings.

This section devotes itself to discuss the following issues:

- General introduction about analytical modelling.
- Solution approaches: Introduction about Genetic Algorithms.
- Related work and previous researches reviewed in traffic engineering.

#### **About Analytical Models**

Developing an analytical model is not an easy process. Engineers willing to develop analytical models and solutions should possess certain skills and knowledge. For instance, this requires a sufficient background in modern mathematics and modelling.

However, mathematics is just a tool. An engineer should know how to utilize these skills to describe a system successfully and effectively, because as they say, “a fool with a tool is still a fool.”

A major problem is that analytical models often fail to exactly imitate the complex real life situations. Therefore, some assumptions are added to simplify the model and overcome the obstacles rising from this complexity. In that context, Einstein once said: “make everything as simple as possible, but not simpler.”

### **2.3.2 Steps of Analytical modelling**

Developing an analytical model is an iterative process. The success of the model is evaluated by answering one simple question: “does the model represent the reality effectively?” Certain procedures should be followed to build a successful model. Figure 2-4 represents these procedures [2-4].

- **Problem Statement:** Identify the problem, the main reason of conducting the study and the expected outcomes from solving the model.
- **System description:** The behaviour of the system in study should be understood carefully and the underlying relations between the different system variables should be deduced.
- **Problem variables:** Enumerate and define all the problem variables.
- **Classification of problem variables:** Problem variables are classified into decision (control variables) and response (output values).
- **Model infrastructure:** Construct appropriate relations between the problem’s variables previously defined.
- **Simplifying assumptions:** The model should include a set of assumptions to overcome the complexity of real life situations. Assumptions should simplify the model, but must not affect the reliability of its results.
- **Model creation:** Specification of decision variables, objective function and limiting constraints.

- **Validation:** The model's validity is checked by calibration (running the model in the current circumstances and comparing the results with the reality). If the model is not validated, the model is revised. Otherwise, the next step is considered.
- **Solving the model:** A feasible and suitable solution approach is proposed for the model.

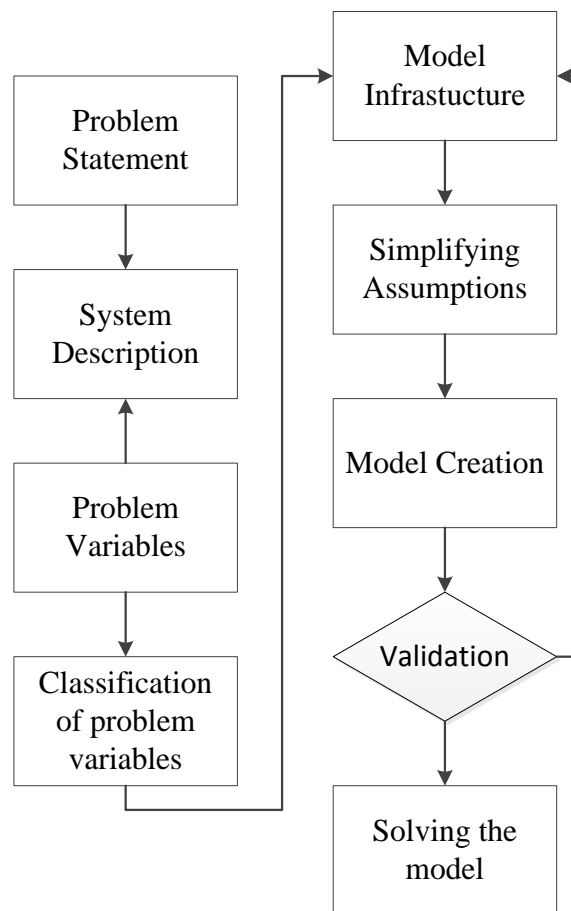

**Figure 2-4: Steps of analytical modeling**

### 2.3.3 Solution Approaches

There exist several methodologies and solution approaches proposed to solve the analytical models concerning the optimization of traffic signal timings. Examples include Genetic Algorithms, Ant Colony approach, neural network approach, cellular

automata, unconventional heuristic models, simulation and simulation optimization, etc...

Based on the researches and references reviewed during the work on this project, the Genetic Algorithm technique is selected as a suitable solution approach for the analytical model developed. Simulation and optimization using simulation is also discussed as a proposed solution approach in further chapters of this report. Genetic algorithm has been proven to be a powerful and effective technique in the optimization of traffic signal timing. It is well known that the heuristic techniques such as GA do not often reach the exact optimum solution. However, they reach a near-optimum solution which is often more than suitable for solving the described problem. The steps and procedures of a successful optimization experiment using Genetic Algorithm are discussed in the following section.

### **Genetic Algorithm**

Genetic Algorithm (GA) was introduced by John Holland in the late 60's. It imitates the Darwinian process of evolution, in order to reach the optimal or near-optimal solution for a defined problem. The basic concept of GA is the competition between the populations of possible solutions until the fittest and strongest solution survives at the end of the optimization process.

A simple GA experiment is an iterative process that consists of the following steps:

1. Selection
2. Cross-over/Copying
3. Mutation

Figure 2-7 represents the sequence of these steps.

First, a random population of possible solutions called chromosomes is generated. Each chromosome contains all the information that describes a solution in form of genes. The fitness of each chromosome is evaluated. The fitness is the measure of goodness that differentiates the chromosomes and ensures the selection of the best solutions from the population. The chromosomes with higher fitness possess larger probability to be

selected and proceed to the next population. Selection process selects candidate chromosomes and makes more copies of these chromosomes in the new population.

Next, cross-over takes place between the mating chromosomes with a specified cross-over probability to exchange their characteristics (genes). Cross-over is used to combine two good chromosomes known as parents, to produce better children in the next population. Figure 2-5 illustrates the cross over process.

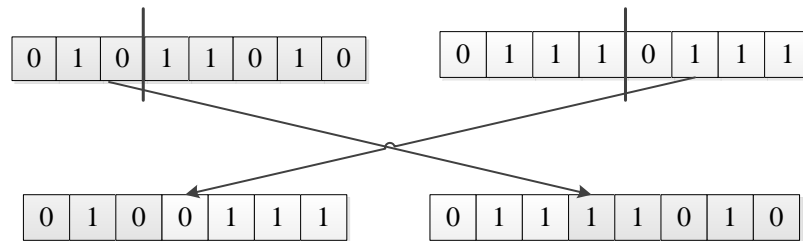

**Figure 2-5: Cross-over process**

The last step is mutation; where, random genes of chromosomes are changed. The change is done based on a specified mutation probability to increase the diversity of the population and to avoid narrowing the space of solutions. Mutation prevents the common local optima problem. Figure 2-6 illustrates the mutation process.

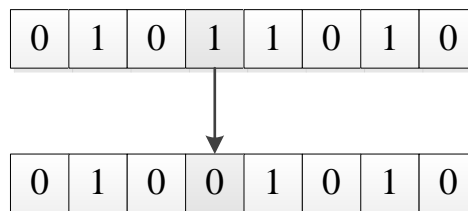

**Figure 2-6: Mutation process**

Hence, the average fitness of the population is improved. The process continues until either a specified value for the average fitness, or a specified number of generations is reached [5-7].



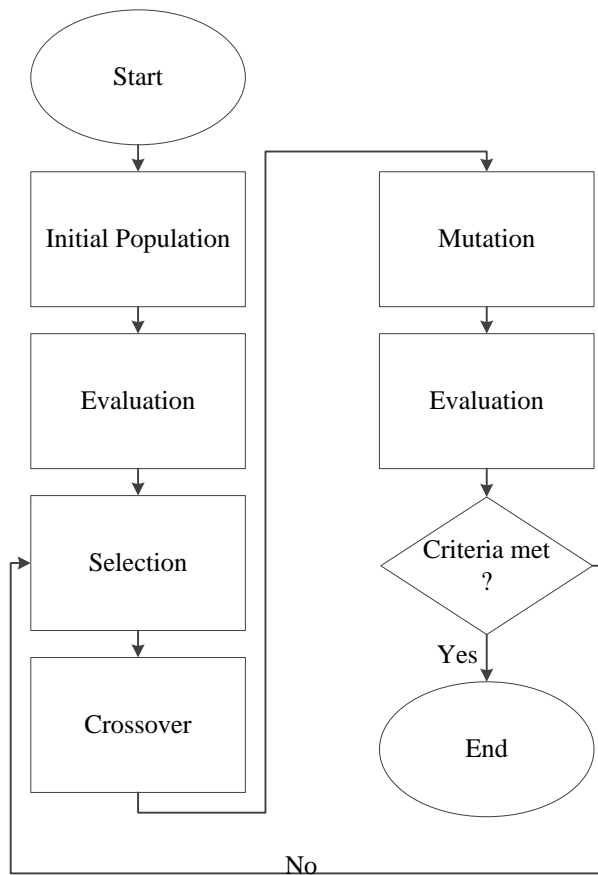

**Figure 2-7: Steps of GA study.**

### 2.3.4 Related Work

A large number of researchers and engineers have developed analytical models for the problem of traffic control timing. Different solutions are proposed to solve these models. Some of these solutions are carried out using the Genetic Algorithm technique, simulation, a combination of both, or other approaches. This section gives a quick overview of some of the researches reviewed.

Webster's model that has been developed in 1958 is considered to be the starting point for all the traffic flow models that came up later. The model's objective is to estimate the overall delay in an isolated intersection. An equation is derived that estimates the delay, depending majorly on the traffic light timings, the arrivals and the intersection's capacity. The Webster's model suggests some assumptions that push the model away from reality, such as the uniform arrival of vehicles, neglecting the random pattern and the variability of the flow. This model was further modified by Webster, and by other researchers to include the randomness effect [8].

Later on, a number of studies have been carried out to model the traffic system and study the effect of signal timings on different performance measures. Some researchers have developed models to minimize the fuel consumption and energy emissions through the improvement of traffic light timings. These researches are very similar despite being performed in different countries [9-11].

In addition, another study carried out in Italy, has developed a mathematical model to describe the urban traffic network and then determined the optimum signal timings in order to minimize the average number of vehicles in queue using professional simulation software [12].

A number of studies have also developed analytical models and have used Genetic Algorithm, or a combination of GA and simulation, to minimize the overall vehicular delay and other performance measures, through optimizing the traffic light timings at isolated intersections or a complicated road network [13-16].

A study that has been conducted in Malaysia uses the GA approach for TSTM (traffic signal timing management). The objective is to develop an adaptive traffic control system used to minimize the overall delay through the optimization of traffic signal timings. The output of the GA is introduced to a simulation experiment where the results are compared to those of the existing pre-timed control system, and returned better performance [17].

Furthermore, another research has been carried out to model the traffic flow, but uses another approach for solving the model, the Ant Colony technique (AC) [18]. Another research has tried to solve the problem of traffic signal timings and coordination where the green timings are the decision variables to maximize the vehicular throughput. The optimization process is done using the Ant Colony algorithm (AC), the Genetic algorithm (GA), and then the results are compared to determine the best output solutions for the problem [19].

## **2.4 SIMULATION**

As mentioned before, analytical models sometimes fail to accurately represent the complexity of real-life situations. Therefore, another computational approach has risen as a powerful tool in the world of research and modelling. Simulation and optimization

using simulation are now used by researchers and engineers to model the most complex real-life systems, such as the traffic environment. In order to proceed with this chapter, a quick overview of the basic concepts of modelling and simulation are presented as follows.

## 2.4.1 Basic Concepts of Modelling and Simulation

### What is Simulation?

The Oxford American Dictionary 1980 defines simulation as “a way to reproduce the conditions of a situation, as by means of a model, for study or testing or training, etc.” To be more specific, simulation can be defined as the imitation of a real world system, by hand or by using a computer model, to evaluate and improve the system performance. Simulation modelling can be used both as an analysis tool for predicting the effect of changes to existing systems and as a design tool to predict the performance of new systems under varying sets of circumstances [20-31].

### Simulation: Systems & Components

A system is a collection of interrelated elements and activities that function together to achieve a specific objective. Any system is composed of many components that must be understood very carefully as shown in Figure 2-8, in order to understand the system itself [26, 27].

- a. **Entities** are the items being processed through the system. For a traffic system, the entities are vehicles which are discrete entities.
- b. **Events** are the actions occurring that affects the system’s state. For a traffic system, activities include the arrivals, the departures and the queuing (waiting) in line.
- c. **States** are the set of variables used to describe the system at any time.
- d. **Resources** are the means used to perform the activities such as equipment and facilities. For a traffic system, resources include the traffic signals, the detection sensors and the roads infrastructure.

- e. **Controls** clarify the order and the behaviour of the system. For a traffic system, controls include queuing behaviour, red and green time intervals, etc...

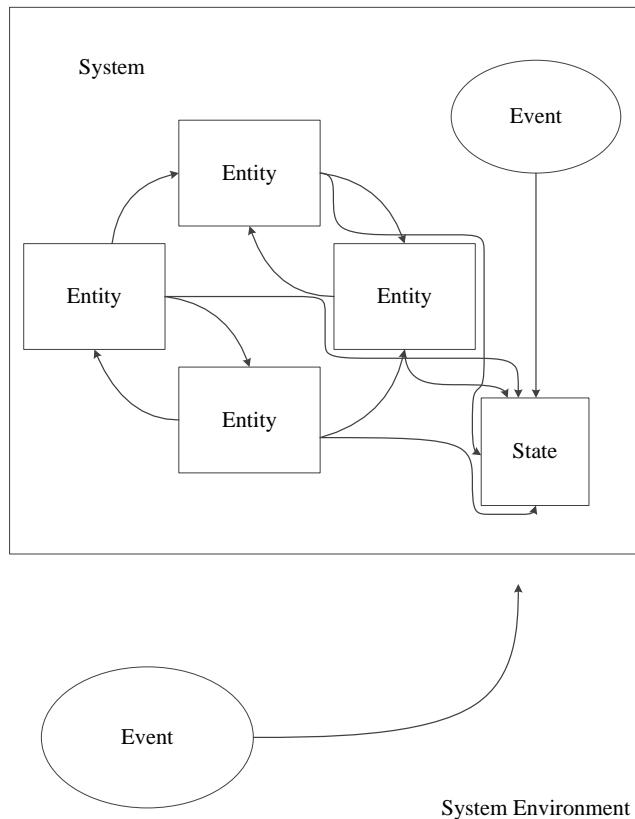

**Figure 2-8: Components of a system.**

### Simulation Models

It is often infeasible, destructive and very costly to experiment with an actual system, and alter it so that it would operate with different conditions, and in some cases this system may not even exist. Therefore, a model of the system is built. A model is a representation of the system for the purpose of studying that system. Models are either physical or mathematical. A physical model is a tangible copy of the system, only different in size; might be larger or smaller. A mathematical model uses mathematical equations and symbols to describe the system [23, 27]. Simulation models are classified under the mathematical models category, as shown in Figure 2-9: Representation of a system

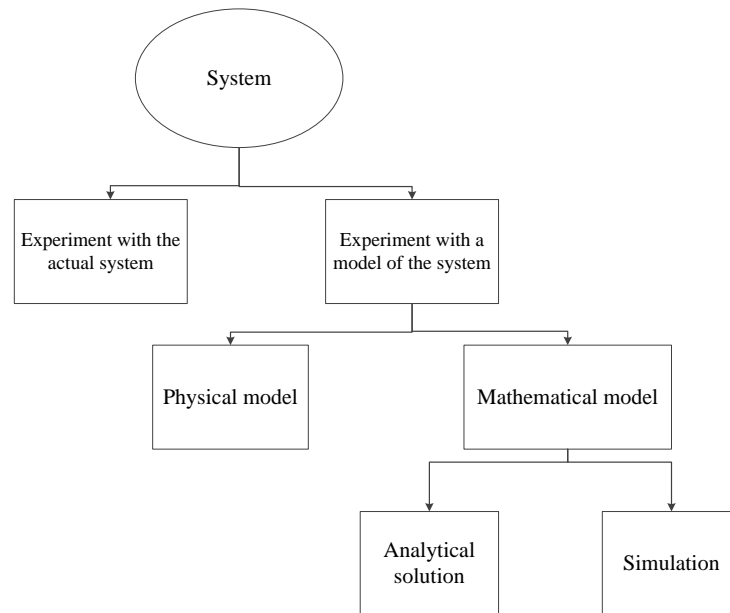

**Figure 2-9: Representation of a system**

## Classification of Simulation Models

Simulation models can be further classified according to the system it represents into the following [26, 27]:

- Static , Dynamic
- Stochastic , Deterministic
- Continuous , Discrete

**Static** models represent a system at a particular point of time, while **Dynamic** models study the system changes over a specified time interval.

**Deterministic** models do not include any type of randomness in its input nor outputs, while in **Stochastic** models, the inputs and outputs are random, and are only an estimation of the true system characteristics.

**Continuous** models are those where the variables change continuously over time, like the water level in water tank. **Discrete** models deal with variables that change only at a discrete set of points in time.

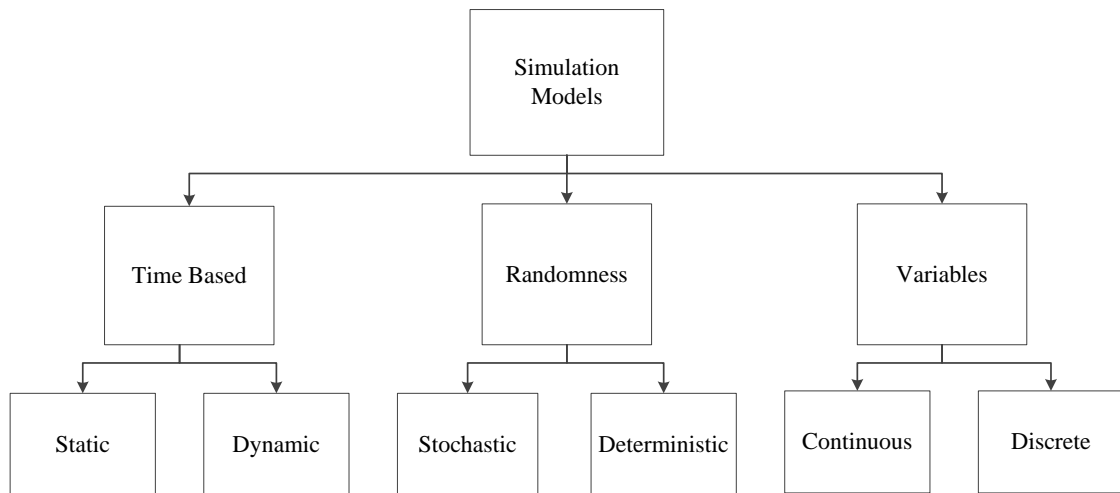

**Figure 2-10: Classification of simulation models.**

## 2.4.2 Simulation Steps

In order to simulate any system, there is a general sequence of steps shown in Figure 2-11 that must be followed. Those steps are a merge of different methodologies from several references [21, 23, 25-27, 29]:

1. **Problem Formulation:** To state and describe the problem and the required objectives clearly.
2. **Modelling:** The construction of a model of the system by defining the decision variables, the objective function and the feasible constraints that regulate and limit these variables.
3. **Data collection:** The collection and gathering of the data required to activate the model. The more the data is accurate, the more reliable and confident the results are.
4. **Model translation:** Entering the model to the computer simulation software.
5. **Model verification:** Checking whether the input parameters and the logical structure of the model entered in the computer are a real representation of the system. If not, the model translation process is reviewed for further adjustments.

6. **Simulation Experiment/ Calibration:** An iterative process in which the model is run at exactly the same actual conditions of the system, and the output results are compared with the real system behaviour.
7. **Validation:** If the calibration results are odd, then there is something wrong with either the modelling phase or the data collected, otherwise the sequence is continued.
8. **Simulation runs:** To run the simulation model with the alternative solutions suggested, and analyse the results to estimate the system performance.
9. **More runs:** To check if the model needs further runs to present reliable, confident output.
10. **Documentation and reporting:** A final report about the simulation process must be presented to clarify the results and add credibility to the model-building process.
11. **Implementation:** Implementing what happened in the simulation on the real system.

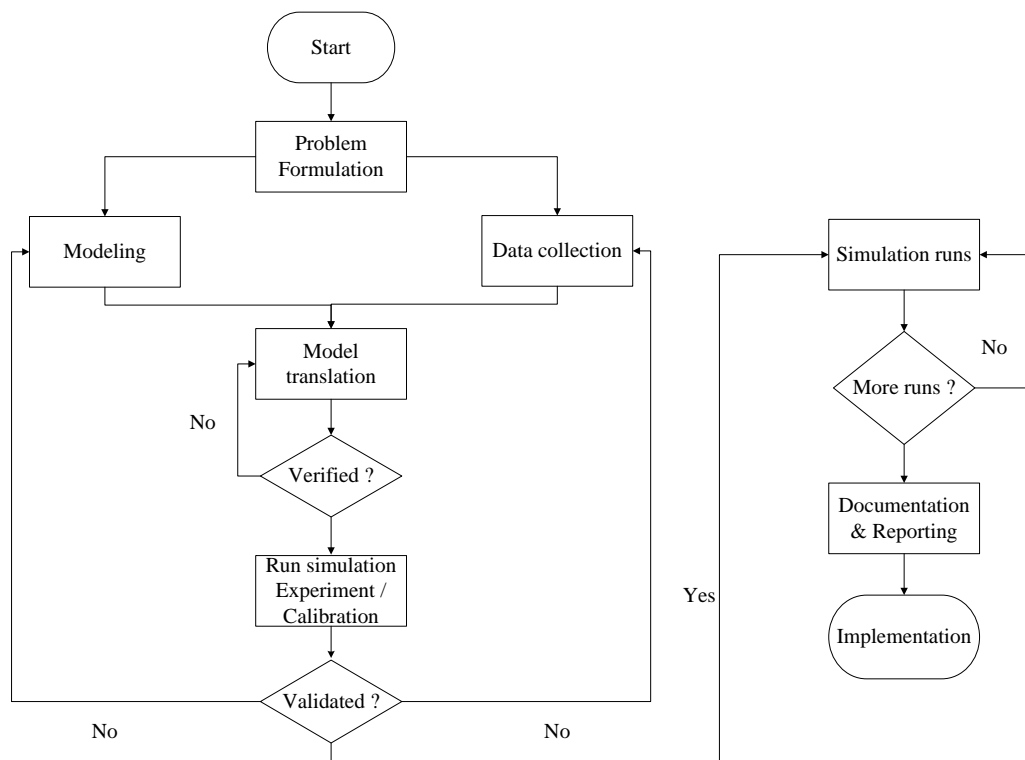

**Figure 2-11: Steps in a simulation study.**

### **2.4.3 Previous Research on the Simulation of Traffic Light Signal Timing**

Many researchers have applied simulation to the problem of traffic light signal timings. They all strive to optimize the traffic light signal timings using specified decision criteria such as the minimization of queue lengths, waiting times, delays, number of stops, maximization of the vehicles throughput and the synchronization of the traffic lights.

Researchers are concerned with one of two traffic control systems, pre-timed, or adaptive. However, the adaptive systems are usually adopted by developed countries, which have already implemented the pre-timed system on their road networks. Therefore, most of the results of the researches under the category of the adaptive systems included a comparison to the performance of a pre-timed system.

#### **Pre-timed Control Systems**

A simulation study has been performed to set the appropriate phase plan for the traditional pre-timed control system. The study aims to improve the traffic performance measures through optimizing the signal timing settings [32].

#### **Adaptive Control Systems**

Many similar simulation studies have been carried out, using different simulation software. These studies were conducted to design an adaptive traffic control system, evaluate its performance, and compare it to that of a fixed-cycle controller. All of the studies are very similar despite the fact that they are performed in different intersections, in different countries [33-36]. A similar study has been conducted, but with more emphasis on the hardware configuration of the adaptive traffic control system [37].

A number of simulation experiments adopt the cellular automata framework to represent the traffic environment on both pre-timed and adaptive control system [38-40].

Some researches performed at different locations, are concerned with the optimization of signal timings, considering the effect of synchronization between isolated



intersections [41-43]. A study has been conducted to determine the optimum transient traffic light settings in order to enhance the traffic flow safety [44].

#### 2.4.4 Optimization using simulation

As analysts and researchers are heading to simulation as an analysis tool of performance, usually a simple evaluation of performance is not enough. Therefore, optimization using simulation is carried out on the simulation model to find the best set of decision variables, in order to meet a certain specified objective, as shown below in Figure 2-12: Simulation optimization process.

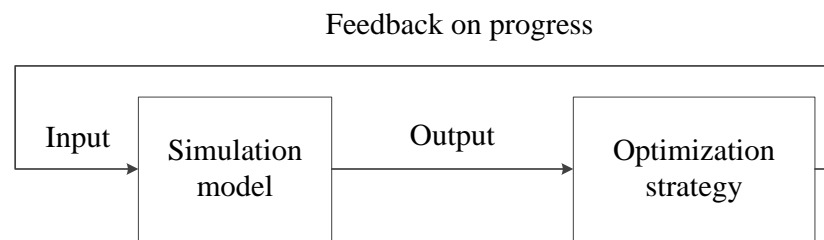
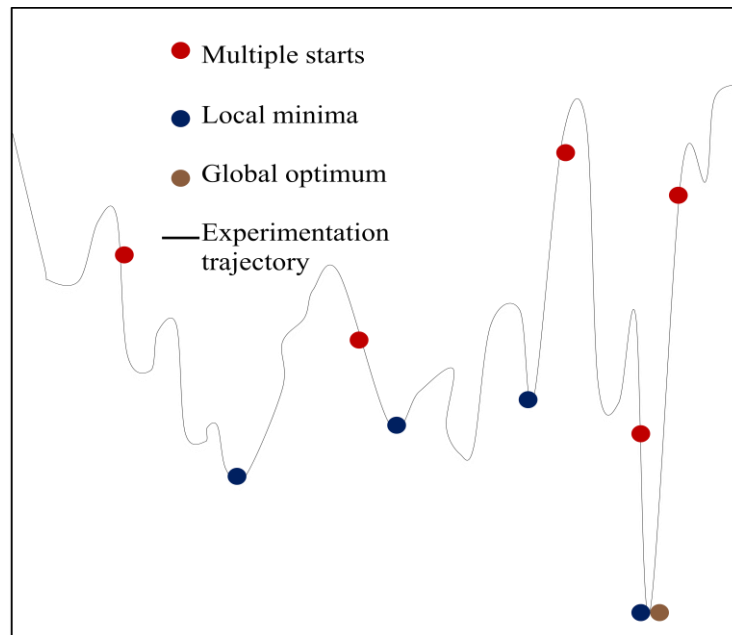

**Figure 2-12: Simulation optimization process.**

However, the combinations of the decision variables that have been reached are not necessarily the optimum solution. A common error in the optimization process is the selection of what is known as the local optima. Figure 2-13 illustrates this local optima dilemma.

A random set of solutions is tried and evaluated, based on the minimization of the objective function. The process of trying new sets of variables is continued as long as the objective function decreases. Once the objective function shows an increase in its value, the evaluation process ends and the point that returned the minimum value for the objective function is considered as an optimum solution, while in reality it is local optima.

Mutation is the process that can overcome the problem of local optima by increasing the diversity of the selected population and expanding the range of possible solutions, in order to reach a near-optimum solution. However, mutation probability should be limited or it might threaten the reliability of the optimization strategy leading it to a random search.



**Figure 2-13: Illustration of optimum vs. local optima**

The optimization can be performed on both discrete and continuous systems. There are many different optimization techniques. Selection of the appropriate technique depends on the analyst preference and the problem to be addressed.

The traditional problem formulation is used for the maximization or minimization of a certain set of values, by defining:

- Decision variables
- Objective function
- Constraints

#### **2.4.5 Previous Research on the Optimization using Simulation of Traffic Light Signal Timing**

Simulation optimization has been used by many researchers to determine the optimum traffic light timings. A research has been carried out by using a hybrid method of simulation and Genetic Algorithm and is compared to the conventional simulation methods [13].

Another research that has been conducted in Sri Lanka, has developed an adaptive traffic control system model, and compared its performance to the existing pre-timed

system, in order to improve the traffic performance measures [45]. Another similar case study follows the same methodology, but only adopts the pre-timed traffic control system [46].

Another experiment models the traffic flow as a stochastic inventory system. The problem is solved using a combination of simulation and dynamic programming [47].

#### **2.4.6 Commercial off- The- Shelf Software Packages COTS**

The software applications that support simulation have recently grown, and spread world widely as the use of simulation has witnessed much growth to replace the traditional analytical solutions that require too much effort & time. The simulation software packages are evaluated on the basis of several factors such as the program's capability, ability to run on different operating systems, user-friendly interface, special features, powerful optimization tools, ability to produce animation & visual demonstration, run time & run speed, etc... The advanced simulation software packages are usually oriented in one professional field such as the simulation of shop floor environment & manufacturing systems, supply chain networks, risk analysis & decision making situations [26].

According to ORMS today magazine "Transportation systems have been increasingly important objects of simulation"; this shows how the simulation packages can be a great tool to analyse and optimize the traffic control systems which are the most critical & important issue of the transportation systems [48].

The following software packages are the most popular software applications used in traffic control [49-51].

- 1- **TRANSYT**: Developed by TRL software, a British software company. TRANSYT is a powerful simulation package used by most of the traffic engineers and analysts for the optimization of traffic light signal timings and signals' coordination and synchronization over road networks. It's most important features are importing current flow data, storing of historical flow data, high run speeds, and being compatible with all types of sensors.

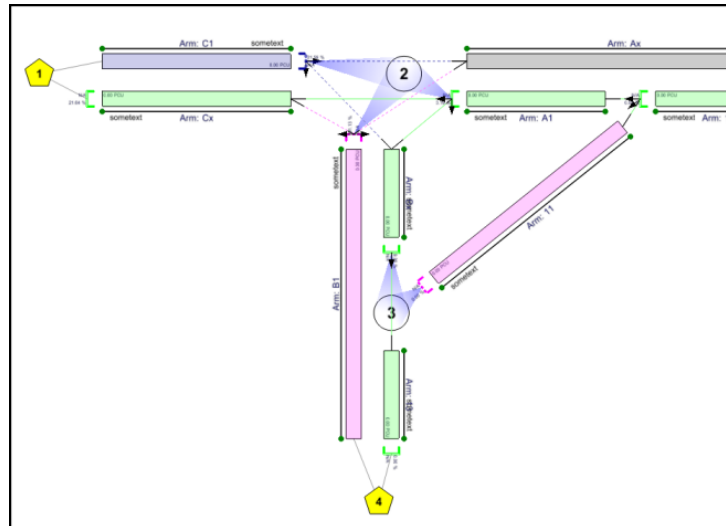

Figure 2-14: TRANSYT software

- 2- **SimTraffic8:** It can simulate the traffic flow of different vehicles and pedestrians, imitating real-world situations. It can also accurately simulate signalized intersections, unsignalized intersections and freeways. The most important features are the ability to create videos for playback, displaying sensors and detectors placements, 3D visualization & animation, optimization tool, remarkable ease of use.



Figure 2-15: Sim Traffic8

- 3- **CORSIM:** It is a critical tool for any transportation engineer to simulate and analyse the most complex real-world traffic situations and help him in the decision making phase between different traffic control strategies. The most important features are modelling of complex geometric intersections, its

ability to consider high variability and system interdependency, user-friendly interface, 3D visualization & animation

- 4- **Synchro**: A powerful traffic analysis application used by traffic engineers for the synchronisation of traffic control and for determining the different performance metrics that describe a traffic flow.
- 5- **Vissim**: A powerful traffic simulation package which is known by its wide variety application in a broad range of networks and traffic systems.

In this project, the ExtendSim8 software package is used to simulate the traffic system. Unlike the previously mentioned simulation software that are specific only to management of traffic systems, ExtendSim8 is a general purpose simulation software. Modelling a real life complex traffic system on this software is expected to represent a considerable challenge.

The ExtendSim8 package is a very powerful tool when it comes to simulation. Its simulation environment provides the tools for all level of modellers to efficiently create accurate, credible and usable models. The ExtendSim facilitates every step of the simulation, ranging from creation, to validating and verifying the model, to the construction of a user interface that allows easy analysis of the system. The program does not require any external interfaces as it covers all the tools required to build a model.

ExtendSim models are built using library based iconic blocks, where each block represents a step or calculation in the model. The software has a drag and drop interface creation, where the blocks are placed on the model by dragging them from the library window, and a flow is then established between the blocks. The blocks are all very easily understood and applied, in order to model very complex systems. In addition, the ExtendSim package provides a suite for communication tools allowing communication with external programs such as Microsoft Excel. It facilitates an evolutionary optimizer which employs powerful algorithms to determine the best model configuration, and offers options for automatic automations and debugging tools, which all aid in validating and verifying a model, and makes it easy for the modeller to see how the model is operating [52-54].

## **2.5 HARDWARE**

Traffic control devices are one of the major components of a successful traffic control plan. In order to address a traffic control problem, the engineer or analyst should possess a background about the common technologies and modern hardware components used in traffic systems.

This section is concerned with the following issues:

- Introduction about the use of traffic control devices.
- The use of traffic devices in data collection and road surveillance.
- Selection criteria of the appropriate device or methodology for data collection.
- Related work and previous researches concerning this problem.
- Decisions taken based on the information presented in this section.

### **2.5.1 Traffic Control Devices: Uses and Applications**

The rapid advancements in hardware components, sensing technologies and controllers have paved the way to traffic engineers and traffic analysts to implement what they have been dreaming of for decades; an “intelligent” traffic system that allows a free smooth flow of vehicles with ideal waiting times and regularly dissipating queues across the signalized intersections of the highly populated cities. Hardware technology has two main applications in traffic engineering.

The first application is the use of sensing devices in detecting the traffic flow volumes crossing a certain control point at a given intersection. The complexity of such hardware varies from simple hand counters and stopwatches used in manual data counting to highly modern sensors such as inductive loops and video image processing detectors.

The second major application of hardware technologies is the implementation of an intelligent traffic control system. The traffic system state is determined, either by modern sensors or by historical information. Then, this state is used by the microprocessor or the FPGA to send signals to the traffic light controller containing the

optimum traffic light settings and timings. Both applications will be included in this project.

## **2.5.2 The Use of Traffic Hardware in Data Collection**

Behind any successful model, there is a reliable data collection methodology. As the famous slogan implies “Garbage In, Garbage out GIGO”, a model with inaccurate input data can lead to irrelevant results which in turn lead to conclusions that do not reflect the real-world system. A signal-timing problem requires accurate input data that represent an estimation of the actual performance of the system. The traffic data collection can be carried out using simple manual techniques or using modern sensors. The selection of an appropriate technique and the critical measure locations for the sensors are major issues concerning traffic systems [55, 56].

### **The data collection methodologies**

#### **Manual data collection**

Manual data collection technique is used usually for counting the traffic flow passing through different control points at a given intersection. The traffic system state can be classified into categories like AM peak, PM peak, and non-peak time. The data collectors observe the traffic system during the different time periods to count and record the traffic volumes. The manual data collection is done through the use of simple tools such as:

- Stopwatches
- Standard tables & sheets.
- Hand counters

#### **Modern sensors**

In this methodology, modern “intelligent” sensors are used to count traffic flow, measure speed, measure travel time and other parameters for both the pre-timed and the adaptive traffic control systems. However, these technologies are usually more important to the adaptive traffic control systems since they provide the traffic signal

controllers with instant input data in order to adjust the traffic light settings automatically [57, 58]. Examples of such equipment include:

**Pneumatic road tube:** This is a special tube, as represented in Figure 2-16, which has a defined pressure. The pressure changes when a vehicle passes over it, sending a pulse to another connected recording device (counter). The major problem of a road tube is that it counts the number of axles passing over it, not the number of vehicles. Therefore, the overall count must be divided by the average number of axles per vehicle, which is obtained by sample measuring. This results in inaccurate data collection and affects the reliability of the data collected.



**Figure 2-16: Road tube**

**Inductive loop sensor:** This type of sensors is commonly used in traffic control. A loop detector consists of one or more loops of wire embedded in the road and connected to a control box. The loop senses the presence of any metallic object passing over through the change in its inductance, sending a signal to the box to count the pass of a vehicle. The equipment is not expensive but requires professional installation as the loops are installed under the road, and must be re-installed every time the road is repaved. This type of detectors is widely used in United States. Figure 2-17 is a representation of an inductive loop sensor.



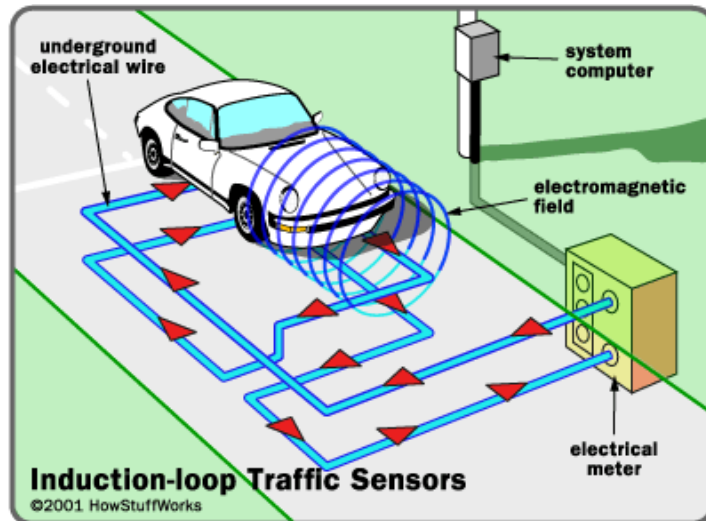

Figure 2-17: Representation of an inductive loop sensor

**Ultrasonic detectors:** This type of sensors, shown in Figure 2-18 is widely used in Japan. They operate by transmitting ultrasonic energy, and measure the energy reflected by the target. These measurements are translated to give indications of vehicle presence. These detectors are very accurate. However, their installation is difficult as it requires sophisticated position adjustments so that the ultrasonic waves accurately hit the vehicles crossing the roads.

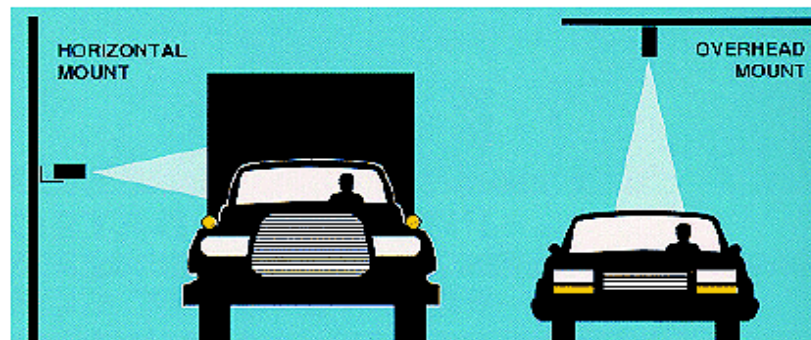

Figure 2-18: Ultrasonic detectors

**Magnetic detectors:** The passage of a metallic object (vehicle) interrupts the magnetic field, which generates a pulse to a connected recorder. The magnetic detectors are not vastly used in traffic engineering due to practical reasons.

**Microwave radar detectors:** Radar detectors use microwave sensors mounted over the travel lane. Energy is sent from the radar unit to the traffic lane and the reflected energy is measured by a sensor. A defined change in the reflected energy indicates the presence of a vehicle. Figure 2-19 represents a microwave radar detector.

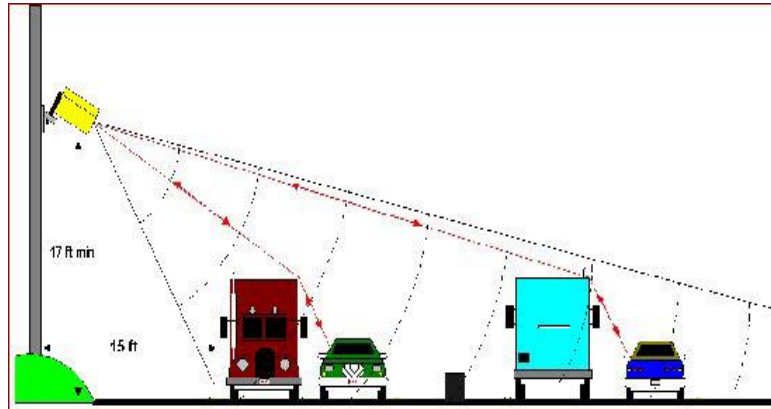

Figure 2-19: Microwave radar detector

**Video image processing technologies VIP:** A video camera as shown in Figure 2-20 captures the traffic flow and a processor translates images into traffic counts.



Figure 2-20: Video image processing technologies VIP

### 2.5.3 Selection Criteria: The appropriate methodology/ traffic hardware

It is well remarkable that the use of modern sensors returns much more accurate data than the manual collection technique. But this does not mean that it is always the most suitable solution for traffic data collection. An analyst or a traffic engineer must select the right tool and the right methodology for the proposed task. Sometimes, using modern “intelligent” sensors for some simple tasks is like killing a fly with a shotgun. Therefore, careful decision-making must be carried out to select the suitable data collection methodology. Several factors should be considered by the decision maker to

select the appropriate data collection methodology, and the correspondent hardware devices used. Examples of these factors are:

- **The nature of the study:** The nature of the study determines the level of accuracy and reliability of data required.
- **The flow parameters required for the study:** This is an important factor in the selection of the appropriate sensor because some sensing devices are mainly capable of measuring certain parameters that other devices cannot measure.
- **The total cost of equipment:** This includes the cost of purchasing and installing the hardware devices.
- **The feasibility:** Most sensors require professional installation, others affect the infrastructure of the road network (the roads should be repaved). In addition, the installation often requires time and massively disrupts traffic flow at congested intersections.
- **Security issues:** These expensive devices are subject to theft or damage.
- **Awareness:** The drivers' and the traffic officers' awareness and response to such technologies.
- **The weather:** The weather of the surrounding environment is a critical measure because some sensing devices do not perform effectively under bad weather conditions.

#### **2.5.4 Related work**

This section is an overview of the different researches and papers evaluated during the work on this project. Many researches and experiments have been conducted either to select the appropriate traffic sensing devices for a case study, or to determine the optimum locations for the traffic sensors in order to accurately collect data from a road network.

A research carried out introduces the different types of traffic sensing devices and determines the optimum locations of traffic sensors on a road network [59]. The same authors of that research also carried out a similar research that classifies sensors

according to their capabilities into two broad categories, passive and active. Then, two decision models have been developed to determine the optimum quantities and locations of traffic sensors in order to obtain sufficient information on vehicular volumes crossing a road network [60].

Another research provides an important introduction about the various types of traffic sensors and the capability of these sensors to detect incidents and unpredictable changes on the road. The research also sheds light on the selection criteria of an appropriate traffic sensor based on several factors concerning the nature of data required, the road infrastructure and the surrounding environment [61].

### **2.5.5 Data collection: Decisions**

The main power of any industrial engineer is the ability to make the right decisions based on knowledge, experience and pre-defined selection criteria. This section includes the conclusions deduced and the decisions taken based on the information presented in the hardware section.

The main conclusion is that the feasibility of installing the above sensors on Alexandria's roads is quite rejected due to several reasons:

- The city is not familiar with modern sensing devices in its road network.
- The introduction of this technology to the city's road network is considered as a project that will require a considerable amount of time to check their effectiveness and enhance the drivers and traffic officers' awareness of such technologies.
- The introduction of this technology must be done with the permission and the coordination with the headquarters of traffic management in the city, because the majority of these sensors require adequate and professional installation that will disrupt the traffic flow intensively.
- The professional traffic sensors' costs are relatively high compared to the available budget.

Therefore, a set of decisions have been taken concerning this project:

- The project will rely on its input data through manual data counts. The manual data collection methodology in field is planned to be discussed in detail in further chapters of this report.
- A small prototype of an intersection is planned to be constructed, and a simplified traffic control system is to be implemented on this prototype using FPGA's as controllers.

## *Chapter three*

### **3 DATA COLLECTION AND STATISTICAL ANALYSIS**

#### **3.1 INTRODUCTION TO DATA COLLECTION**

Data collection is the process of gathering and collection of required data in order to obtain adequate information about a particular system, in this case the traffic system. It fully describes the system parameters, inputs, processes, and consequences.

The process of data collection is one of the most important and challenging phases in modelling. The output or final results of any model greatly depend in first place on the input collected data. Therefore, it is necessary for any gathered data to be accurate and reliable in order to ensure valid results.

#### **3.2 DATA COLLECTION IN TRAFFIC CONTROL**

When studying an actual traffic system, in order to evaluate and experiment with it, various aspects of input data should be measured. A major decision in traffic engineering and control is the method of data collection. The different types of data collection methods have been previously discussed in the literature review chapter. A brief of those methods are described below.

##### **a. Manual data collection**

Manual data collection involves assigning individuals to record traffic flow passing through different control points at a given intersection. The data collectors observe the traffic system during the different time periods to count and record the traffic volumes. The manual data collection is done through the use of simple tools such as stopwatches, standard tables and sheets, and hand counters. Generally, a traffic system state can be classified into categories like AM peak, PM peak, and non-peak time.

##### **b. Data collection using modern traffic sensors**

In this method, modern traffic sensors are used to count traffic volumes, measure speed, measure travel time and other parameters for both the pre-timed and the adaptive traffic

control systems. However, these technologies are usually more important to the adaptive traffic control systems since they provide the traffic signal controllers with instantaneous input data in order to adjust the traffic light settings automatically. Decision in data collection

### **3.2.1 Manual versus modern sensors**

A decision must be taken to determine whether to adopt the manual data collection, or the modern sensors methodology, in this traffic control study. It is important to compare the advantages and drawbacks of each data collection methodology in order to attain a suitable decision.

Despite the fact that the manual method of data collection is more time and energy consuming than modern traffic sensors in terms of manpower, it is greatly reliable and considered most suitable for short term studies. On the other hand, the installation of modern sensors on the road network would require professional background, and would cause major disruption to the traffic system in study.

Therefore the choice is made that the required data for this traffic control study is to be collected manually. This method is more adequate in Alexandria's roads as discussed earlier in the literature review chapter.

### **3.3 DATA COLLECTION PLAN**

The demand and flow of vehicles differs as the day progresses. There are certain times where people are rushing to get to and back from work and school, creating excessive traffic congestion. There are also other times during the day where there is a comparatively low demand of vehicles.

Furthermore, there are certain exceptions to the daily demand, for instance during the weekend people are off work and schools, resulting in less traffic during the regular rush hours.

All of those variations in the vehicle demand throughout the day and week need to be considered carefully, when gathering the data, in order to achieve both valid and

consistent figures. In order to successfully do so, it is necessary to classify the different periods resulting each day.

The day has been divided into five different periods, each at different intervals in the day, and each interval is classified whether it is a peak time or not. This is represented in Table 3-1.

**Table 3-1: day classification into periods**

<b>Period</b>	<b>Time interval</b>	<b>Peak/ non-peak</b>
1	7-9 am	PEAK
2	9-1 pm	NON-PEAK
3	1-5 pm	PEAK
4	5-11 pm	NON-PEAK
5	11-7 am	NON-PEAK

The time periods classified as peak times, indicate the times when the volume and the demand of the vehicles is at its maximum, resulting in the largest queue lengths and waiting times, as a result of those times being rush hours. Period 1 is the A.M. peak, which is the time where everyone is heading off to schools and work. Whereas, period 3 is the P.M. peak, indicating the time that everyone is leaving from work.

### **3.4 LIST OF SYSTEM PARAMETERS & VARIABLES TO BE MEASURED**

Before starting the process of field data collection, a list of the system parameters and variables that need to be measured must be written down carefully. The enumeration of these variables is a major step that requires careful analysis of the model under construction, adequate understanding of the addressed problem and of course taking in consideration the trade-off between the available resources and the accuracy of the required data.

The following is a list of defined key parameters and system variables that need to be measured:

- **Arrival rates (vehicles/sec)**

Arrival rates are characteristic system parameters representing the demand pattern. The demand pattern varies from one control point to another in a single road network and



from a period to another in a single day. For example, studying an intersection of (3) control points over (5) periods in a day would require us to calculate (15) arrival rates.

Arrival rates can be expressed mathematically as:

$\lambda_j$ : *Arrival rate at Control Point (j)*

- **Departure rates (vehicles/sec)**

Departure rates are characteristic system parameters representing the throughput and the volume capacity. Same as arrival rates, they vary from one control point to another and from one period to another in a single day.

$\mu_j$ : *departure rate at Control Point (j)*

- **Left/Right turn volumes & proportions**

A vehicle crossing a certain control point has usually one or two options more than going straight forward with the main stream. Vehicles sometimes turn right or left when the left/right turns are available in a control point. Hence, Left/Right Turn volumes must be measured, and expressed as a proportion from the total demand pattern.

$V_{secondary_j}$ : *Left or Right turn volumes at Control Point (j)*

- **Actual Signal timings**

Actual signal timings displayed must be recorded. The aim of this project is to simulate the performance of the actual model, and propose better alternatives through the optimization of traffic signal timings. These parameters are very important in order to compare them with the reached solutions and calculate the percentage improvement in system performance (if any).

$TG(actual)_j$ : *green timing interval for a control point (j)*

$TR(actual)_j$ : *red timing interval for a control point (j)*

- **Average signal time lost**

This parameter represents the amount of time lost in a state timing due to blockages from previous state, vehicles passing right after the end of the previous state, reaction of drivers to signal lights and time taken to reach steady state flow. The parameter is an indicator of actual system performance and helps making an adequate estimation of the yellow timing (transient state timing) between states.

$T_L(actual)_i$ : *Lost time interval for a state (i)*

- **Estimated Road capacities**

Capacity in traffic engineering may have two definitions. The geometrical capacity of the road (control point) represents the maximum queue length that can accumulate in this control point. And the other definition of capacity is the maximum number of vehicles dissipating from that control point in a specified period of time. Here, the geometrical capacity is taken into consideration as a crucial parameter in modelling the traffic system, because the other definition is expressed in terms of dissipation rates.

$L_j$ : *Max. Capacity of Control Point (j)*

### **3.5 SAMPLE SIZE**

In order for the data collection methodology to be valid, it is necessary that the data collected is both accurate and precise. The collected data needs to be an actual representative of the demand of cars in the intersection. Calculating the optimum sample size is a major problem in statistical analysis. However, as a rule of thumb, we can say that the more samples you can have, the better the data pattern is, for numerous reasons.

First of all, it reduces or eliminates the opportunity of any errors occurring. It also confirms the accuracy of the entire data collection procedure. In addition, increasing the number of samples at one intersection under relatively identical conditions increases the total sample size, which is a great advantage as it is more representative of the population, limiting the influence of outliers or extreme observations. Having a large

sample broadens the range of possible data, and forms a better picture for the statistical analysis.

For all of those reasons listed above, four different samples of the data were collected, for the same intersection.

### **3.6 DATA COLLECTION METHODOLOGY**

Another matter of importance, other than categorizing the day into different periods and collecting several samples, are the identification of different points of measurement in the intersection. In order to gather all of the relevant information and parameters required, such as the arrival rates and departure rates etc. certain positions and points of measurement in the field itself need to be assumed in order to allow correct measurement of all the variables.

For instance, in order to measure the arrival rates of the vehicles at a certain control point, the person collecting the data needs to assume a position before the traffic light signal, where the vehicles can be seen arriving to this control point from a distance, and making an allowance for any queuing that may occur.

As for the collection of any departure rates, the measurer must be positioned after the traffic light signal with a minimal distance, in order to clearly observe the cars dissipating from the control point as the traffic light signals turn green.

Figure 3-1 illustrates the layout of both Gamaa' intersection's 1 and 2 where the data collection was pursued multiple times. The arrows represent the flow of cars, and the numbers represent the respective control points. The red points indicate the position of the measurer when collecting arrival information and the yellow points represent the position for measuring the departures of vehicles.

Now that the data collection process is carried out, the output of data collection is transferred into Microsoft Excel 2010 spread sheets for further statistical analysis.

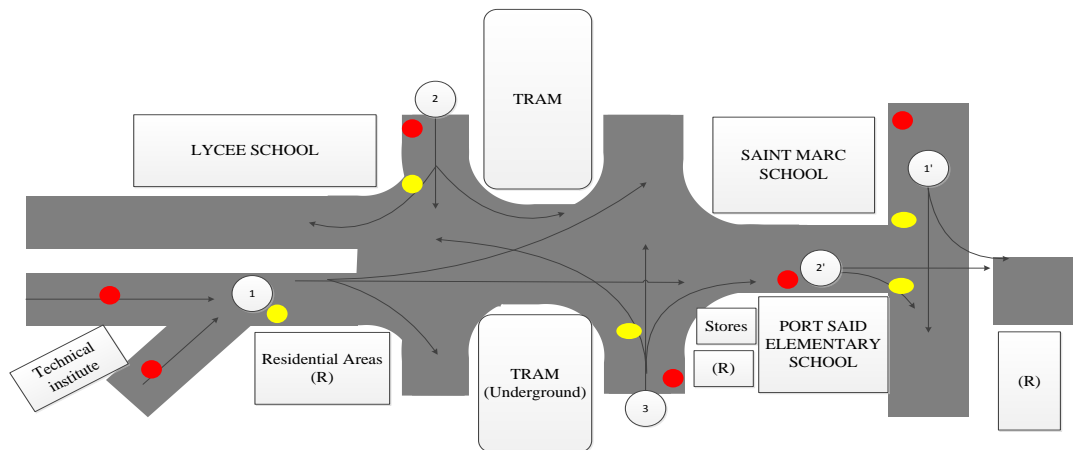

**Figure 3-1: measurement positions in a road network**

### **3.7 INTRODUCTION TO STATISTICAL ANALYSIS**

Statistical analysis is the process of examination and interpretation of quantitative data to discover its underlying causes, patterns, relationships, and trends.

Due to the presence of increased variability in data, such as the data manually collected for this study, these numbers cannot be used directly as they are measured. It is essential and obligatory that the data is first filtered using statistical analysis procedures, to eliminate any outliers or exceptional values that may result from the collector's technique.

### **3.8 BOXPLOTS**

Boxplots are extremely effective graphical summaries of a set of data points, usually showing the data's lowest and highest values, the mean, median, 25<sup>th</sup> and 75<sup>th</sup> percentiles, as well as identifying the outliers as shown in Figure 3-2. In addition, boxplots are capable of comparing different distributions, showing the basic differences between them, and they succeed in portraying extreme values.

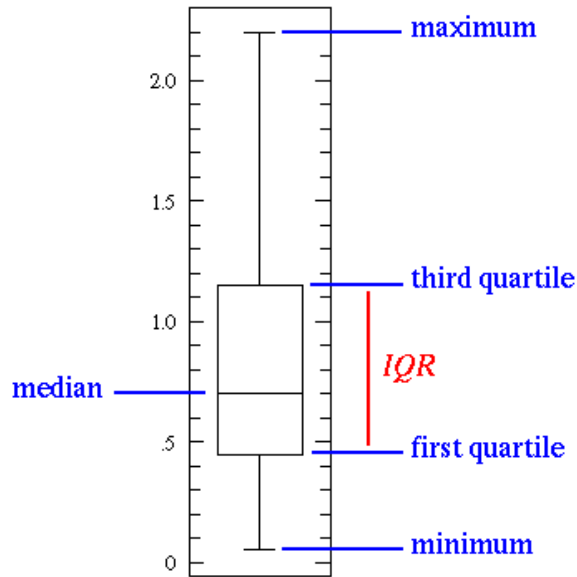

Figure 3-2: Boxplot

### 3.8.1 Theory of operation:

#### a. Data Arrangement

The first step to be carried out for performing the boxplot is that all the data (the volume and inter arrival times) corresponding to the same time period, and same measurement (whether arrivals or departures) from the different samples gathered, is collected and placed in the same Excel file.

After the data is collected, the inter arrival times are ordered from the lowest value to the highest value.

The maximum ( $X_{max}$ ), minimum ( $X_{min}$ ) and the number of observations  $N$  are identified.

#### b. Calculating the 1<sup>st</sup> quartile (Q1)

The first quartile, also known as the lower quartile is the 25<sup>th</sup> percentile.

$$G1 = 0.25 * N$$

Through a series of excel formulation, the value of the inter-related time corresponding to the position  $G1$  is found, and that value is the lower quartile  $Q1$ .

**c. Calculating the 3<sup>rd</sup> quartile**

The third quartile, also known as the upper quartile is the 75<sup>th</sup> percentile.

$$G3 = 0.75 * N$$

Through the series of excel formulation, the same is done for finding the value of time corresponding to the position  $G3$ , and that value is the upper quartile  $Q3$ .

**d. Calculating the inter-quartile range**

This range is given by the difference between the first and third quartiles, and multiplying it by 1.5

$$1.5 * IQR = Q3 - Q1$$

**e. Calculating the lower adjacent limit**

This is given by the difference between the first quartile, and the minimum value in the data set. If the result is smaller than  $1.5 * IQR$  then the minimum value is not an outlier and is within acceptable range.

$$\text{If } Q1 - Xmin < 1.5 * IQR, \text{ then accept } Xmin$$

If this equation is not satisfied, than  $Xmin$  is rejected and eliminated from the data as it is considered to be an outlier. The same procedure is repeated to the new value of  $Xmin$ , and the trial is continued until it satisfies the equation above.

**f. Calculating the upper adjacent limit**

This is given by the difference between the maximum value in the data set and the third quartiles. If the result is smaller than  $1.5 * IQR$ , the maximum value is accepted.

$$\text{If } Xmax - Q3 < 1.5 * IQR, \text{ then accept } Xmax$$

If this equation is not satisfied, and the result is greater than 1.5 times the inter quartile range, then the maximum value is an outlier, therefore is rejected and eliminated from

the data. The same procedure is then repeated for the new value of  $X_{max}$  until it satisfies the equation above.

### g. Collecting the new data points

After completing the prior steps, and eliminating any outlying points, the new data is collected leaving behind any points that have been eliminated. Those steps are repeated for all the different measurements, at all 5 time periods of the day, for all the different samples. Figure 3-3 below represents an example of an excel sheet illustrating the format of boxplot procedure that has just been discussed.

ARRANGED DATA			BOXPLOT		new population	
Volume	Inter-arrival time	Clock(seconds)	Volume	Inter-arrival time	MAX	Inter-arrival time
1	0	0.64	1	0	66.6	0
2	0.25	0.89	2	0.24	0	0
3	2.17	3.06	3	0.24	282	0.24
4	0.95	4.01	4	0.24	G1 70.5	2 0.24
5	2.99	7	5	0.25	G2 141	3 0.24
6	1.03	8.03	6	0.26	G3 211.5	4 0.24
7	1.22	9.25	7	0.27	IQR = 1.9	5 0.25
8	1.09	10.34	8	0.29	1.5*IQR= 2.85	6 0.26
9	0.99	11.33	9	0.31	Q1-Xmin 1.02 <1.5IQR, then do not reject	7 0.27
10	4.34	15.67	10	0.32	X182-Q3= 63.68 >1.5*IQR, then reject X182, X181 is the max	8 0.29
11	2.37	18.04	11	0.34	X181= 55.32	9 0.31
12	10.44	28.48	12	0.34	Xmax-Q3= 52.4 >1.5IQR, then reject X78	10 0.32
13	43.31	71.79	13	0.37	and so on	11 0.34
14	0.26	72.05	14	0.38	Reject till X258, accept X257	12 0.34
15	1.26	73.31	15	0.38		13 0.37
16	0.91	74.22	16	0.4		14 0.38
17	2.03	76.25	17	0.41		15 0.38
						16 0.4
						17 0.41

Figure 3-3: boxplot output displayed on excel sheet

## 3.9 DATA FITTING AND ANALYSIS

### 3.9.1 Introduction to Statfit

Statfit is a data analysis software, developed by Geer Mountain Corporation. It is included as a statistical distribution fitting package in the simulation software Extendsim8. Extendsim8 is the simulation software that is going to be utilized intensively throughout the work on this project to model the traffic control system. This will be discussed later in subsequent chapters.

This section discusses the use of Statfit software for data treatment, fitting and analysis.

### 3.9.2 Data fitting results

Now that the box plotting procedure has been carried out on the data and the outliers that might disturb the uniformity of the data have been removed, the population becomes quite ready to the next step, which is the data fitting.

Each set of data, is entered to the Statfit software, which performs the statistical data fitting and outputs a range of accepted random distributions with their correspondent characteristic parameters (mean, St.dev, scale, shape, Etc...)

Seven intersection points are to be considered in the data pattern. Table 3-2 to Table 3-5 represent a summary of the results of statistically analysing the collected data using Statfit.

**Table 3-2: average proportions for left/right turns**

Int.	Type	Left/Right Turn Description	Proposed average proportion
1	LT	PortSaid to Corniche	0.25
	RT	Tram to Portsaid	0.25
2	LT	Aboeir to sporting tram	0.1
	RT	Aboeir to shatby tram	0.2

**Table 3-3: road capacities for control points**

Int.	CP	Road Capacity (vehs.)
1	1'	80 – 100
	2'	80 – 100
2	1 (B1)	80 – 100
	1 (B2)	20 – 30
	1 (Com.)	20
	2	60 – 80
	3	90 – 120
	4	20

**Table 3-4: percentage time lost in signal timing**

Int.	CP	% Time lost in signal timing
1	1'	4 %
	2'	11.2 %
2	1	12.6 %
	2	15.4 %
	3	16.3%
	4	N/A



**Table 3-5: Random distributions for arrivals**

Period	Int	A. Point	Proposed distribution for arrivals	Proposed range of average inter-delay time (sec)
7-9am	1	1'	Weibull(1.29,3.67) Exponential (3.33)	1
		2'	Weibull(1.66,2.03) Exponential (2)	0.5
	2	1 (branch1)	Weibull(1.66,2.08) Exponential (2)	0.7
		1(branch2)	Weibull(1.52, 3.73) Exponential (3.7)	
		2	Weibull(1.59,2.63) Exponential (2.34)	0.5
		3	Exponential (2)	1
		4	N/A	0.2
9-1pm	1	1'	Weibull(1.42,4.53) Exponential (4)	0.2
		2'	Weibull(1.68,1.53) Exponential (2.8)	0.2
	2	1 (branch1)	Weibull(1.66,2.05) Exponential (3)	0.5
		1(branch2)	Weibull(1.37,5.25) Exponential (4.73)	
		2	Weibull(1.58, 2.83) Exponential (2.52)	0.5
		3	Exponential (3)	0.7
		4	N/A	0.2
1-5pm	1	1'	Weibull(1.4,2.19) Exponential (2.5)	0.7
		2'	Weibull(1.75,1.39) Exponential (1.43)	0.5
	2	1 (branch1)	Weibull(1.37,1.65) Exponential (2.5)	0.7
		1(branch2)	Weibull(1.41,4.07) Exponential (3.66)	
		2	Weibull(1.57, 2.73) Exponential (2.43)	0.5
		3	Exponential (2)	0.7
		4		0.2
5-11pm	1	1'	Weibull(1.15,7) Exponential (5)	0.5
		2'	Weibull(1.67,1.56) Exponential (2.5)	0.2
	2	1 (branch1)	Weibull(1.72,2.14) Exponential(6)	0.5
		1(branch2)	Weibull(1.35, 6.46) Exponential (9)	0.5
		2	Weibull (1.32, 2.8) Exponential (2.56)	0.5
		3	Exponential (2.5)	0.7
		4		0.2

Period	Int	A. Point	Proposed distribution for arrivals	Proposed range of average inter-delay time (sec)
11-7am	1	1'	Weibull(1.5,15) Exponential (10)	0.2
		2'	Exponential (7)	0.2
	2	1 (branch1)	Exponential (9)	0.2
		1(branch2)	Exponential (10)	0.2
		2	Exponential (6)	0.2
		3	Exponential (5)	0.2
		4		0.1

## **4 ANALYTICAL MODELING AND SOLUTION USING GENETIC ALGORITHM APPROACH**

### **4.1 INTRODUCTION**

Modelling is known as the process of developing a model of a system for the purpose of analysis and improvement. In chapter III, Two major preliminary steps were accomplished:

- **The Data collection process:** A set of system parameters and variables were measured accurately and regularly in field.
- **Adequate statistical analysis:** Convenient treatment was carried out on the collected data to obtain an accurate data pattern as input for the model under construction.

This chapter devotes itself to discuss:

- **Analytical model formulation:** The formulation of a general analytical model that represents the traffic system in study. A general model formulation is designed to fit for any given road network and represent any traffic control system.
- **Optimization using Genetic Algorithm:** This section presents “Optimization using Genetic Algorithm approach” as the first proposed solution among a set of other solutions discussed in this project. Based on previous work methodologies and successful experiments adopted by researchers in the field of traffic control analysis, Genetic Algorithm has been proven to be a very powerful and common tool used for the optimization of traffic signal timings.

## **4.2 ANALYTICAL MODELING**

“The formulation of the problem is often more essential than its solution.” This is what the greatest scientist of the 20<sup>th</sup> century has told us. Albert Einstein, the greatest problem solver of all time definitely believed in the crucial importance of the model formulation step because it gets us more acquainted with the problem, and more qualified to find reliable solutions.

Analytical modelling, also called the process of model formulation, is the first step towards modelling of any system. Any proposed solution throughout this project will be based on this model formulation. The analytical modelling process encompasses several steps that were discussed in detail in the literature review chapter. The same steps can be summarized as follows:

- Problem Statement.
- System description and problem layout.
- Enumeration of Decision Variables: These are the control variables.
- Enumeration of system parameters: system characteristic parameters.
- Enumeration of Response Variables: The output variables which are affected by the change in the decision variables.
- Proposed objective function(s)
- Enumeration of governing constraints
- Proposed solution approach(es).

### **4.2.1 Problem Statement**

You simply cannot solve a problem, if you do not understand it adequately. In order to develop a model that represents the current system under study, the engineer should have in mind a clear understating of the existing problem. Therefore, a short and clear problem statement should be written down as a preliminary step. The problem statement has been discussed in detail in chapter I and can be summarized as follows:

Traffic congestion is a crucial problem in highly populated cities such as Alexandria, Egypt. Due to the absence of an effective control strategy for the regulation of traffic signal lights, a massive inflation of the vehicles' queue lengths and the waiting times emerges. Through field observation, the signal light timings were observed to be fixed through all the periods of the day, which does not correspond to the randomness of the time-fluctuating demand of vehicles.”

In addition, the main aim of the conducted study should be clarified. This should represent the main motive behind the work. The main aim of this model is to provide a reliable representation of the traffic control system and propose a solution approach in order to solve the addressed problem. The solution should optimize the values of a set of decision variables in order to minimize/maximize the specified objective function as much as possible.

#### **4.2.2 System Description and Problem Layout**

Defining system description and problem layout is a very important step in problem identification. This step qualifies the engineer to analyse the system surely and start the journey of searching for feasible solutions. It is this step where the behaviour of the system is recorded and analysed carefully.

Several system characteristics should be recorded:

##### **A clear layout of the road network under study:**

A clear layout for the road network in study should be drawn in order to visualize the problem and understand its underlying root causes.

For example, Figure 4-1 is the layout of two consecutive intersections in Alexandria, Egypt which we are going to study throughout this project:

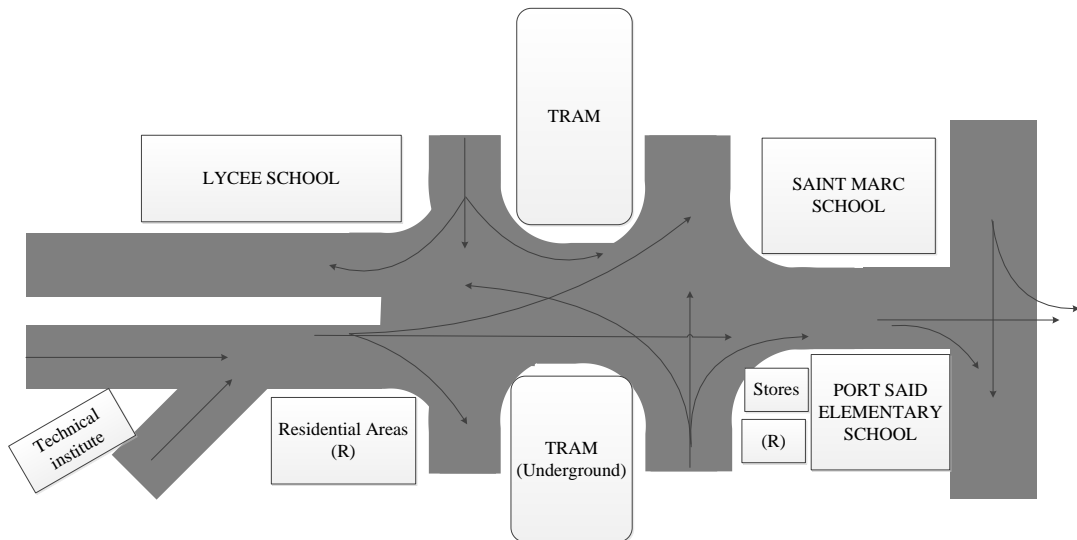

**Figure 4-1: Layout of one of Alexandria’s road networks**

### **Defining the time periods of characteristic demand patterns in the system**

The day is classified into time periods/intervals having characteristic demand patterns. This classification is left to the experience and field observation of the traffic engineer in charge and depends basically on the location of the intersection which defines the peak and non-peak intervals. Each period of the day has different demand patterns and as a result, it will be assigned different signal timings in a pre-timed that are correspondent to the demand patterns (arrival rates).

Applying this step to the two consecutive intersections studied, Field observations and the geographic location (residential & educational facilities) necessitate that the day should be classified into five major periods as shown in Table 4-1. All the problem variables & system parameters that are introduced in this model are period-dependent; however, the model will be applied in each period separately.

**Table 4-1: Periods of the day**

<b>Period</b>	<b>Time interval</b>	<b>Peak/ non-peak</b>
1	7-9 am	PEAK
2	9-1 pm	NON-PEAK
3	1-5 pm	PEAK
4	5-11 pm	NON-PEAK
5	11-7 am	NON-PEAK

## Phase plan defined

This step involves defining the current road network's phase plan and whether it needs any modification. As discussed in chapter I, A phase plan in traffic control encompasses:

- Enumeration of the control points that are (need to be) signalized. (A control point is a point in the intersection having characteristic demand pattern and whose flow is opposing to one of the existing streams, therefore, signalization is needed to organize the process). Figure 4-2 shows the road network in study after defining the control points on it.

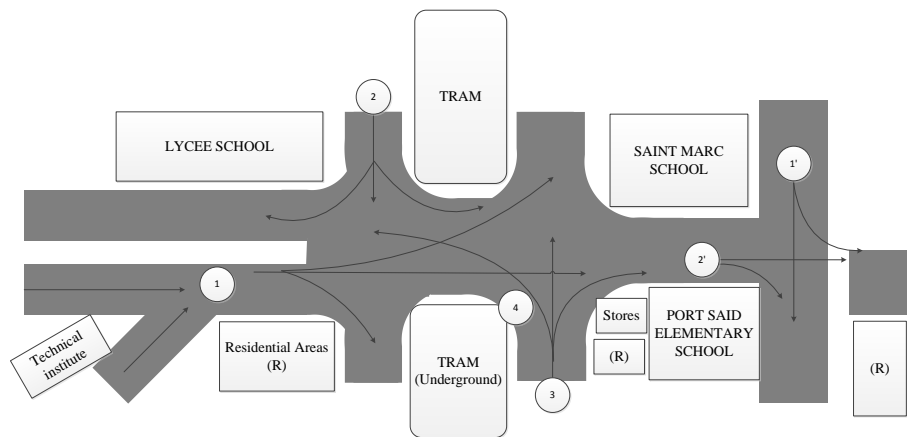

**Figure 4-2: road network with control points defined**

- Enumeration of the feasible states/phases. (A traffic state is a set/combination of traffic signals rendered to a number of control points in a specified intersection).

The phase plan process must be done considering the demand of each control point, the geometrical design of the intersection and the accidents' hazard.

For example, applying this step on the road network under study, we would have a phase plan for each intersection in the road network studied:

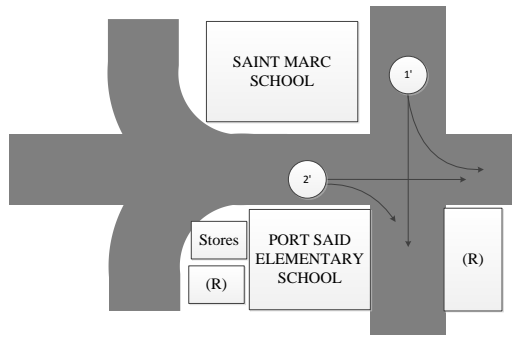

Figure 4-3: layout of intersection 1

Table 4-2: Phase plan of intersection (1)

State	Control Point		State timing (sec)
	1'	2'	
A'	R	G	$T_A = 50$
B'	G	R	$T_B = 60$

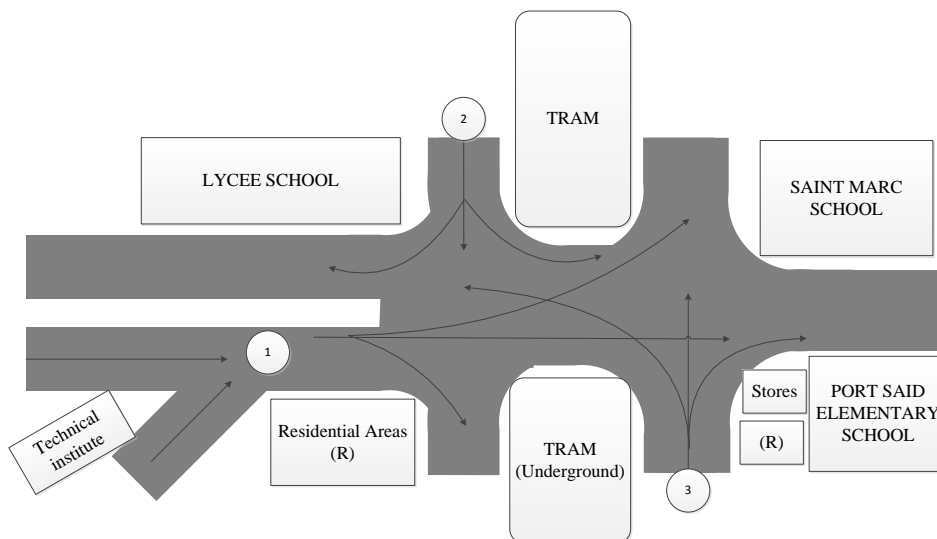

Figure 4-4: Layout of intersection (2)



**Table 4-3: Actual Phase plan of intersection (2)**

State	Control Point			State timing (sec)
	1	2	3	
<b>A</b>	R	G	G	$T_A = 50$
<b>B</b>	G	R	R	$T_B = 70$

By regular field observation, it has been proved that the current phase plan of intersection (2) is neither accurate nor reliable. Therefore, a proposed phase plan has been proposed.

**The proposed phase plan for intersection (2):**

A point in the intersection which represents the left turn from control point (3) must be identified as a control point since it satisfies the two conditions (characteristic demand pattern, and opposing flow to one of the main streams of the intersection). This modified phase plan will be the input for the solution scenarios proposed that will be discussed throughout the core of this project.

**Table 4-4: Proposed phase plan of intersection (2)**

State	Control Point				State timing
	1	2	3	4	
<b>A</b>	G	R	R	R	$T_A$
<b>B</b>	R	G	G	R	$T_B$
<b>C</b>	R	R	G	G	$T_C$

### 4.2.3 Enumeration of Problem Decision Variables

Decision variables, also called control variables, are the set of variables that need to be determined in order to solve the problem. Through experimentation, the values of these variables are changed, and the effect of this change is measured constantly. Finding the best values for this set of variables will definitely cut off the root causes of the addressed problem.

The general model under construction considers any road network in a single period with (L) consecutive intersections, (N) feasible states and (M) control points, where:

$$\text{number of consecutive intersections: } k = \{1, 2, 3, \dots, l\}$$

$$\text{number of states: } i = \{A, B, \dots, N\}$$

$$\text{number of control points: } j = \{1, 2, 3, \dots, M\}$$

Hence, the general phase plan that can be applied on any given intersection will be as shown in Table 4-5.

**Table 4-5: General phase plan of a road network**

State	Control Point					State timing
	1	2	3	...	M	
A	{G,R}	{G,R}	{G,R}		{G,R}	$T_A$
B	{G,R}	{G,R}	{G,R}		{G,R}	$T_B$
C	{G,R}	{G,R}	{G,R}		{G,R}	$T_C$
..						..
N	{G,R}	{G,R}	{G,R}		{G,R}	$T_N$

The decision variables are then listed as follows :

$T_{ik}$  : *State timing(i) intersection(k), where  $i = \{A, B, , N\}, k = \{1, 2, \dots l\}$*

$CT_k$  : *Cycle time of the intersection, where  $CT_k = \sum_{i=A}^N T_i$*

It is well remarkable that the cycle time of the intersection is the sum of the state timings of the intersection. These variables are period-dependent, however we assume the model should be applied in each period separately.

For further clarification, the road network under study will have two state timings in intersection (1), three state timings in intersection (2) , and one cycle time for each intersection:

$T_{A1}$  : *State timing of state (A) in intersection (1)*

$T_{B1}$  : *State timing of state (B) in intersection (1)*

$T_{A2}$  : *State timing of state (A) in intersection (2)*

$T_{B2}$  : *State timing of state (B) in intersection (2)*

$T_{C2}$  : *State timing of state (C) in intersection (2)*

$CT_1$  : *Cycle time of intersection (1), where  $CT_1 = \sum_{i=A}^B T_{i1} = T_{A1} + T_{B1}$*

$CT_2$  : *Cycle time of intersection 2, where  $CT_2 = \sum_{i=A}^B T_{i2} = T_{A2} + T_{B2} + T_{C2}$*

However, an important point that must be clarified is that the state timings are not the timings that are going to be programmed and displayed on the traffic light signals.

These are called: the traffic signal timings where:

$TG_{jk}$  : *the green timing interval for a control point (j) in an intersection (k)*

$TR_{jk}$  : *the red timing interval for a control point (j) in an intersection (k)*

The green & red timings for each control point are not decision variables. State timings are. The green & red timings are calculated using the state timings previously mentioned. A quick glance to the phase plan will tell the engineer how to calculate the green & red time intervals for each control point using the state timings. For example, using the phase plan of intersection (2) shown in Table 4-6:

**Table 4-6: Phase plan used for signal timing calculation**

State	Control Point				State timing
	1	2	3	4	
A	G	R	R	R	$T_A$
B	R	G	G	R	$T_B$
C	R	R	G	G	$T_C$

Looking vertically in the column of control point (1) through the different states, it is noticed that control point (1) exhibits green timing interval during state (A) only. Hence

$$TG_1 = T_A$$

Same applies for all the control point as follows:

$$\begin{aligned} TG_1 &= T_A, & TR_1 &= T_B + T_C \\ TG_2 &= T_B, & TR_2 &= T_A + T_C \\ TG_3 &= T_B + T_C, & TR_3 &= T_A \\ TG_4 &= T_C, & TR_3 &= T_A + T_B \end{aligned}$$

Now, we would have another definition (equation) for the cycle time than the one previously mentioned:

$$CT_2 = T_A + T_B + T_C = TG_1 + TR_1$$

Hence, by generalizing the above equation we would have the following:

$$CT_k = \sum_{i=A}^N T_i = (TG + TR)_j, \forall j = \{1,2,3, \dots, M\}$$

Where:

$CT_k$  : the cycle time of intersection (k), where  $k = \{1,2, \dots, l\}$

$T_i$  : state timing (i), where  $i = \{A, B, \dots, N\}$ ,  $N$   
: the number of states in intersection (k)

$TG_j$  : green timing interval for a control point (j), where  $j = \{1,2,3, \dots, M\}$ ,  
 $M$  : the number of control points in intersection (k)

$TR_j$  : red timing interval for a control point (j), where  $j = \{1,2,3, \dots, M\}$ ,  
 $M$  : the number of control points in intersection (k)

#### 4.2.4 Enumeration of system parameters

These are the characteristic parameters of the system. In a traffic control system, we could list the arrival rates representing the demand pattern, the departure rates representing the vehicles' throughput (network capacity), and the geometrical capacities of the road network.

They can be listed as follows:

- **Arrival rates (vehicles/sec)**

$\lambda_{jk}$ : Arrival rate at Control Point (j) in intersection (k),  
where  $j = \{1, 2, \dots, M\}, k = \{1, 2, \dots, l\}$

- **Departure rates (vehicles/sec)**

$\mu_{jk}$ : departure rate at Control Point (j) in intersection (k),  
where  $j = \{1, 2, \dots, M\}, k = \{1, 2, \dots, l\}$

- **Geometrical road capacities (vehicles)**

$L_{jk}$ : Max. Capacity of C. Pt(j) in intersection (k), where  $j = \{1, 2, \dots, M\}, k = \{1, 2, \dots, l\}$

#### 4.2.5 Enumeration of the Response variables

During modelling process, it is highly recommended to differentiate between decision variables and response variables. Response variables, also called dependant variables, are those that change accordingly with the change of the decision variables. They are the output values that are being affected by changing the decision variables' values.

In the general model under construction, the response variables are listed as follows:

- **Queue lengths (vehicles)**

$LQ_{jk}$  : Queue length forming at control point (j) in intersection (k),

$$\text{where } j = \{1, 2, \dots, M\}, k = \{1, 2, \dots, l\}$$

A simple equation is developed to calculate the queue length at any control point. Assume we have a control point (1) in a given intersection, having an arrival rate of 5 vehicles/sec. The control point will certainly exhibit green & red timing intervals consecutively  $TG_1$  &  $TR_1$ ,

Then the queue length forming during  $TR_1$  (during red interval, arrivals have a value, while departures are equal to zero) would equal to:

$$LQ_1 = \lambda_1 * TR_1$$

While the queue length forming during  $TG_1$  (both arrivals and departures have a value) would equal to:

$$LQ_1 = (\lambda_1 - \mu_1) * TG_1$$

Then, the queue length in a one cycle time (  $CT = TG_1 + TR_1$  ), would be the sum of the two above equations:

$$LQ_1 = \lambda_1 * TR_1 + (\lambda_1 - \mu_1) * TG_1$$

This equation can be generalized at any control point (j) in a given intersection to represent the queue length forming during one cycle time as follows:

$$LQ_j = \lambda_j * TR_j + (\lambda_j - \mu_j) * TG_j, \text{ where } j = \{1, 2, \dots, M\}$$

$$(\lambda_j - \mu_j) \geq 0$$

If we want to calculate the queue length forming at the end of a certain period of time (p), then we can simply calculate the number of cycles = period interval / CT , and multiply the number of cycles in a period (p) by the queue length forming during one cycle.

Other related response variables are calculated using values of queue lengths such as average queue length in the control point ( $\overline{LQ}$ ) & Maximum queue length occurring in the control point ( $LQ_{max}$ ).

- **Vehicle's Waiting time**

Average waiting time is the average time spent by the vehicle in queue until it passes the cross line of the traffic signal departing from the intersection.

$WQ_{jk}$ : average waiting time of a vehicle at control point ( $j$ ) in intersection ( $k$ ),

where  $j = \{1,2,3, \dots, M\}$  &  $k = \{1,2,3, \dots, l\}$

#### **4.2.6 Proposed Objective Function(s)**

In the literature review phase, a large range of different proposed objective functions has been adopted by experimenters all over the world. Some experiments tend to minimize some crucial variables such queue lengths, waiting times, average time spent in the system by a vehicle. Others tend to the maximization of the network's throughput, dissipation rates and other parameters. While some other experiments consider the environmental approach of the problem by aiming to minimize fuel consumption and gas emissions.

For this experiment, four objective functions are proposed. The four objective functions are more likely to be used throughout the course of the research in different solution approaches.

##### **a. Minimization of Queue lengths**

The first proposed objective function tends to the minimization of queue lengths. This can be done by two methods:

- Minimization of the maximum of the average queue lengths forming among all the control points of the intersection in study. I.e. The average queue length in each control point is computed or measured, and the aim is to minimize the maximum of these values.

$$\text{Min. of } z = \text{Max} \{ \overline{LQ} \}_j, \text{ where } j = \{1, 2, \dots, M\}$$

- Minimization of the sum of the average queue lengths forming among all the control points of the intersection in study. The average queue length in each control point is computed or measured, and the aim is to minimize the sum of these values.

$$\text{Min. of } z = \sum_{j=1}^M \overline{LQ}_j, \text{ where } j = \{1, 2, \dots, M\}$$

In this equation, weights can be assigned to each control point to assign priorities for the control points in study. For example, if there is a main stream that has a very high demand pattern compared to other control points, larger weight is multiplied by the value of its queue length. This leads to concentrate the minimization process on this control point than the others. Hence, the general objective function becomes:

$$\text{Min. of } z = \sum_{j=1}^M (\overline{LQ} * w)_j, \text{ where } j = \{1, 2, \dots, M\}, w: \text{estimated weight} \leq 1$$

#### **b. Minimization of Maximum Waiting time**

The second proposed objective is to minimize the maximum of the average waiting times forming among all the control points of the intersection. The average vehicle's waiting time for each control point is computed or measured, and the aim is to minimize the maximum of these values.

$$\text{Min. of } z = \text{Max} \{ WQ \}_j, \text{ where } j = \{1, 2, \dots, M\}$$

#### **c. Minimization of a characteristic function**

The third proposed objective is to cut off the value of a developed characteristic function. The function is assumed to be the maximum of the products of two response variables in each control point: Queue length & Waiting time of the control point. The value of this function is computed in each control point, and the aim is to minimize the maximum of these values.

$$\text{Min. of } z = \text{Max} \{ LQ * WQ \}_j, \text{ where } j = \{1, 2, \dots, M\}$$



The concept of this objective function will be used in the Genetic Algorithm experiment. However, each chromosome will have this characteristic fitness function to evaluate the goodness of the chromosome. This will be discussed in detail later on in this chapter.

**d. Minimization of the efficiency of the Average time spent in the system**

The fourth proposed objective is the maximization of the efficiency of the average time spent in system. The best average time spent in system is calculated under the best timing conditions for each control point, and then divided by the actual average time spent in system. This objective function will be used in the optimization using simulation experiments and will be discussed in chapter XIII in detail.

$$Max. z = (\sum_{j=1}^M \frac{\overline{TS}^{*jk}}{\overline{TS}_{jk}}) * \frac{1}{M}$$

Where:

$$j = \{1,2, \dots, M\} \text{ and } k = \{1,2,3, \dots, l\}$$

$$\overline{TS}^{*j} = \text{best average time spent in system}$$

$$\overline{TS}_j = \text{the actual average time spent in system}$$

**4.2.7 Enumeration of Governing Constraints**

Constraints can be simply defined as the limits of the problems' variables. They define the feasible range of the problem variable to ensure that the reached solution is feasible and effective.

In the analysis of any road network, the constraints would be as follows:

- **Geometrical Capacity Constraint**

The maximum queue length occurring in any control point in the network should not exceed a certain characteristic limit which is the road capacity of the control point in

study expressed in vehicles (  $L_j$  ). This capacity is different from a control point to another in a given road network.

$$(LQ_{max})_j \leq L_j \quad \forall j, \text{ where } j = \{1, 2, \dots, M\}$$

For better system performance and in order to take precautions, an estimated factor whose value is less than one can be multiplied by the road's capacity. This is done in order to create a safety allowance to ensure that the maximum queue length at each control point will never reach any close to the capacity limit.

The general equation in that case is to be:

$$(LQ_{max})_j \leq (fL)_j \quad \forall j, \text{ where } j = \{1, 2, \dots, M\}, f: \text{ the safety factor } f \leq 1$$

- **Signal timings Constraint**

It is a matter of logic to notice that the signal timings should not exceed certain specified limits. For example, it is logically unacceptable to have a very short green/red timing interval TG of 5 or 10 seconds even if it is going to satisfy the proposed objective function. Neither it is acceptable to have extremely long timing intervals of more than 120 seconds for example, or cycle times that exceed a certain reasonable limit.

These limits are estimated depending on the experience of the traffic engineer and the careful field observation.

$$(T_{lower\ limit})_j \leq (TG, TR)_j \leq (T_{upper\ limit})_j,$$

$$\text{where } j = \{1, 2, \dots, M\}$$

$$(CT_{lower\ limit})_k \leq CT_k \leq (CT_{upper\ limit})_k,$$

$$\text{where } k = \{1, 2, \dots, l\}$$

The red/green signal timings constraints can be transformed to express the limits of the state timings (the problem decision variables) using the relationships previously deduced from the phase plan that relate the state timings and the signal timings. For example if  $TR_1 = T_A + T_B$ , then the constraint will be:

$$(T_{lower\ limit})_j \leq (T_A + T_B) \leq (T_{upper\ limit})_j$$

## **4.2.8 Proposed Solution Approaches**

At this point, the model formulation is nearly completed. The decision and response variables, the objective function and the governing constraints are clearly defined. The last step of the model development is to propose a feasible solution approach and start implementing it to solve the addressed problem. Throughout the course of this project, three different solution approaches are adopted; Optimization using Genetic Algorithm, Simulation, and Optimization using Simulation.

This chapter will emphasize on the first proposed solution approach which is the “optimization of traffic signal timings using Genetic Algorithm.”

## **4.3 PROPOSED SOLUTION APPROACH: GENETIC ALGORITHM**

The concept of Genetic Algorithm was discussed in the literature review chapter. However, a quick review of Genetic Algorithms and their applications should be introduced before going through the structure of the proposed solution approach.

### **4.3.1 Introduction to Genetic Algorithms**

Genetic Algorithms are inspired by the Darwinian process of evolution, in order to reach the optimal or near-optimal solution for a problem. The simple concept of a G.A experiment is the struggle between the different possible solutions called chromosomes until the fittest and strongest solution survives at the end of the optimization process.

A simple GA experiment is an iterative process that consists of the following steps:

- Selection
- Cross-over/Copying
- Mutation

First, a random population of chromosomes is produced. Each chromosome contains a set of decision variables that represent a solution in form of genes. The fitness of each chromosome is evaluated. The fitness is the measure of goodness of the chromosomes of the population. The chromosomes with better fitness possess larger probability to be selected and proceed to the next population. Selection process chooses two candidates in order to carry out the reproduction operation.

Next, the reproduction operation is carried out either through cross over or copying (with a considerably larger probability assigned to cross-over). Cross-over takes place between the mating chromosomes with a specified cross-over probability to exchange their characteristics (genes). Cross-over is used to combine two chromosomes known as parents, to produce better children in the next population. Figure 4-5 illustrates the cross over process.

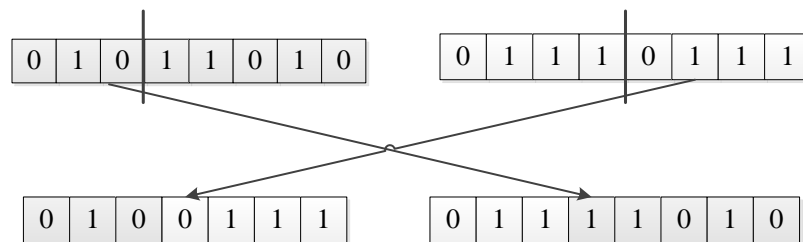

**Figure 4-5: Cross-over process**

On the other hand, copying is the process of replacing the worst two chromosomes in the population by the two selected candidates. The last step is mutation; where, random genes of chromosomes are changed based on a pre-specified mutation probability. The main aim behind mutation is to increase the diversity of the population and to avoid narrowing the space of solutions. Mutation prevents the well-known local optima problem. However, mutation probability should not be large enough to ruin the optimization strategy and transform it into a random search. Figure 4-6 illustrates the mutation process.

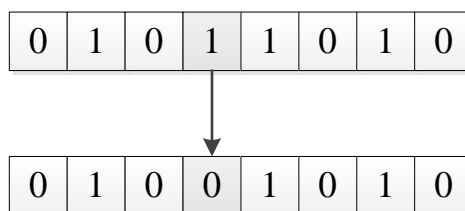

**Figure 4-6: Mutation process**

Hence, the average fitness of the population should be improved. The process is pursued until a specified criteria is met, either a specified value for the average fitness, a specified number of generations or there is no further improvement that can be done. Figure 4-7 illustrates the steps of a Genetic Algorithm Experiment

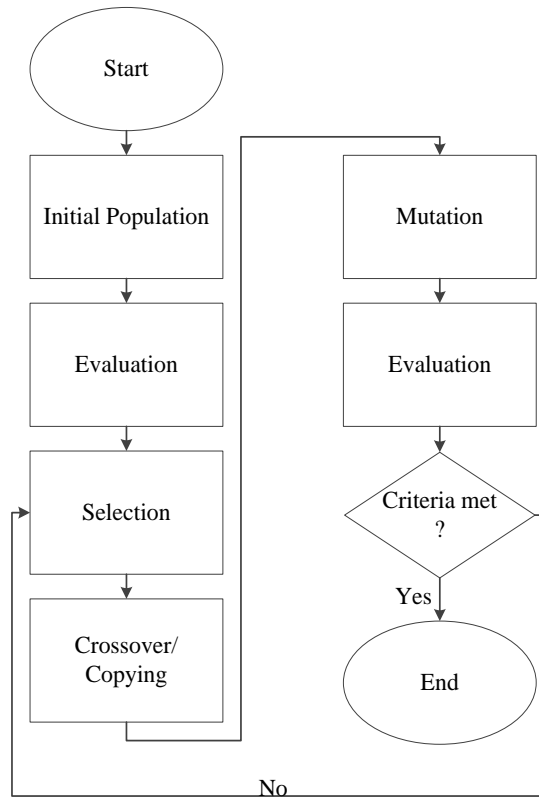

Figure 4-7: G.A. steps

### 4.3.2 Solution approach structure: Optimization of traffic signal timings using Genetic Algorithm

The Optimization using Genetic Algorithm is carried out using Visual Basic Applications VBA in Excel 2010.

#### A. Problem layout

The solution approach will be applied separately to two consecutive intersections in Alexandria, Egypt.

## Intersection 1:

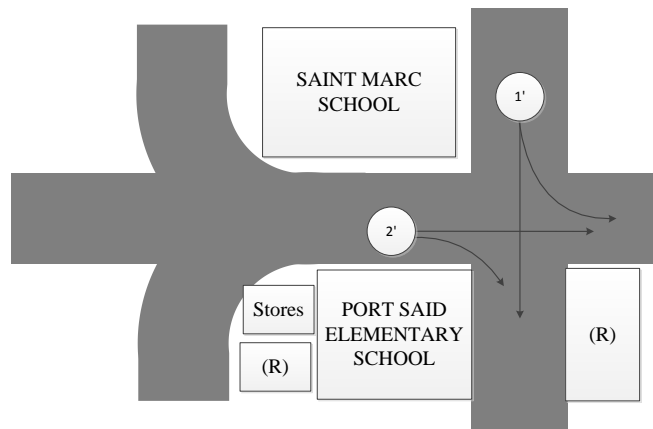

**Figure 4.8: Layout of Intersection (1)**

The control points are identified clearly on the intersection. The phase plan will be as shown in Table 4-7: (the state timings mentioned are those currently applied in the intersection)

**Table 4-7: Phase plan of intersection (1)**

State	Control Point		State timing (sec)
	1	2	
<b>A</b>	R	G	$T_A$
<b>B</b>	G	R	$T_B$

Number of control points = 2

Number of states = 2

Number of periods = 5

The study has been applied to different periods of the day mentioned previously.

## Intersection 2:

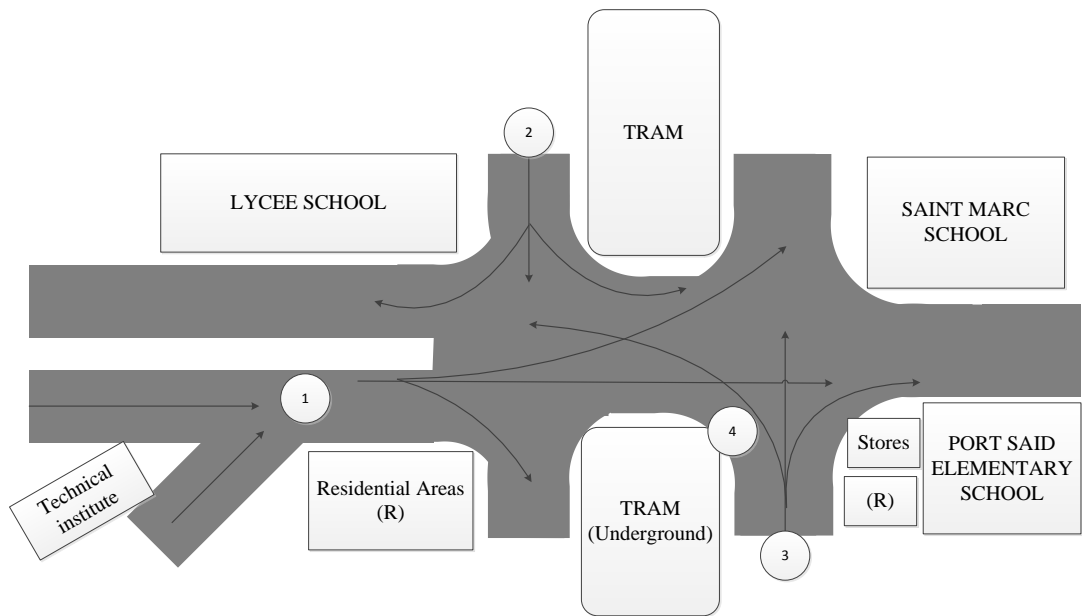

**Figure 4-10: Layout of intersection (2)**

The control points are identified on the layout. As mentioned earlier when developing the model, control point 4 is currently not defined in the actual system. It has been added to accurately develop a reliable phase plan. The phase plan of the intersection is defined as shown in Table 4-8:

**Table 4-8: Proposed Phase plan of intersection (2)**

State	Control Point				State timing
	1	2	3	4	
A	G	R	R	R	$T_A$
B	R	G	G	R	$T_B$
C	R	R	G	G	$T_C$

Number of control points = 4

Number of states = 3

Number of periods = 5

## **B. G.A Experiment parameters**

Defining the Genetic Algorithm parameters accurately is a crucial factor for the success of the experiment. It greatly boosts the possibilities of attaining an optimum/near-optimum solution. Those parameters include the population size, required number of generations to attain a certain level of convergence, cross-over, mutation and copying probabilities. However, there is no general rule to define those parameters. They are estimated based on the size of the problem, the required convergence level. They vastly depend on experimentation, together with the experience of the experimenter in charge.

For each intersection, a G.A experiment is conducted with different parameters.

### **For intersection1:**

- Population size = 50 chromosomes
- Number of generations = 3000-4000 generations
- Cross over probability = 0.95
- Copying probability = 0.05
- Mutation probability = 0.05-0.1

### **For intersection2:**

- Population size = 50 chromosomes
- Number of generations = 5000-6000 generations
- Cross over probability = 0.95
- Copying probability = 0.05
- Mutation probability = 0.1-0.2

## **C. Chromosome Structure**

The general model that was developed earlier is very useful in modelling the optimization process. However, little adjustments are to be done to fit for the Genetic Algorithm experiment.

The decision variables are the same as those listed in the developed model (state timings and cycle time). The chromosome is composed of (N) genes carrying (N) decision



variables. The number of genes depends on the number of states in the intersection. I.e. if we have an intersection consisting of three states, we would have a four genes chromosome. The first three genes are three proportions that represent the state timings. These proportions -when multiplied by the intersection's cycle time- give the required state timings of the intersection. The fourth gene is the intersection's cycle time. Figure 4-11 shows the chromosome structure.

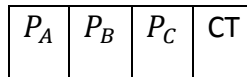

**Figure 4-11: Chromosome structure in G.A experiment**

$P_A$  : *proportion of state (A) from the intersection's cycle time*

$P_B$  : *proportion of state (B) from the intersection's cycle time*

$P_C$  : *proportion of state (C) from the intersection's cycle time*

$CT$  : *the intersection's cycle time*

#### **D. Fitness Function**

The fitness function is a characteristic function that defines the goodness of the chromosome. The function is assumed to be the product of the maximum queue length and the maximum waiting time of the chromosome by using the chromosome's decision variables.

$$\text{Fitness Function } z_n = (LQ_{max} * WQ_{max})_n$$

*where n : the chromosome's index ranging from 1 to population size*

#### **E. The G.A program**

As mentioned earlier, the program is written using Visual Basic Applications VBA in Excel 2010.

- **The program's flowchart**

The code is divided to a number of flowcharts as in Figures 4-12, 4-13, 4-14 and 4-15.

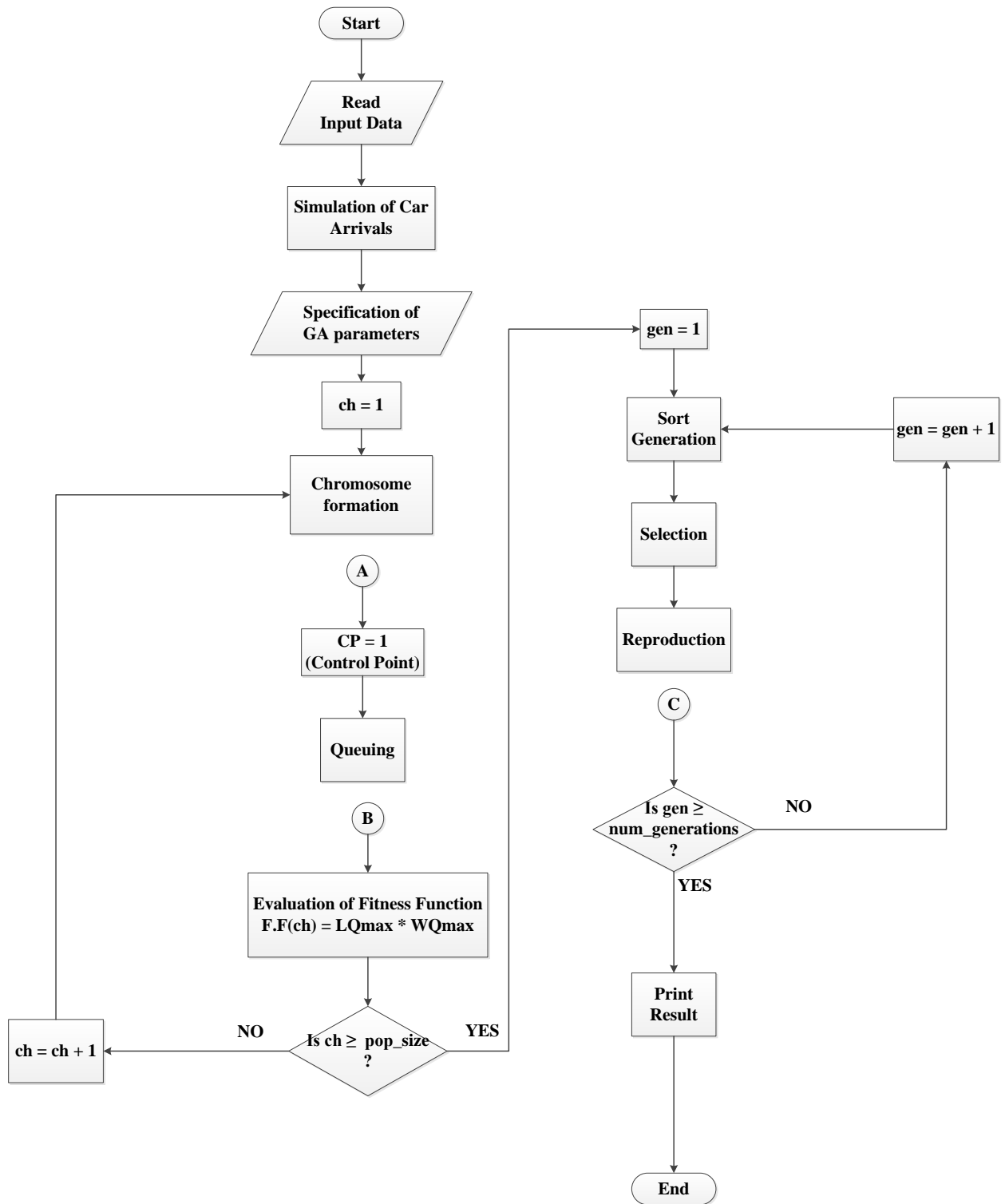

Figure 4-12: Main flowchart of the GA VBA code

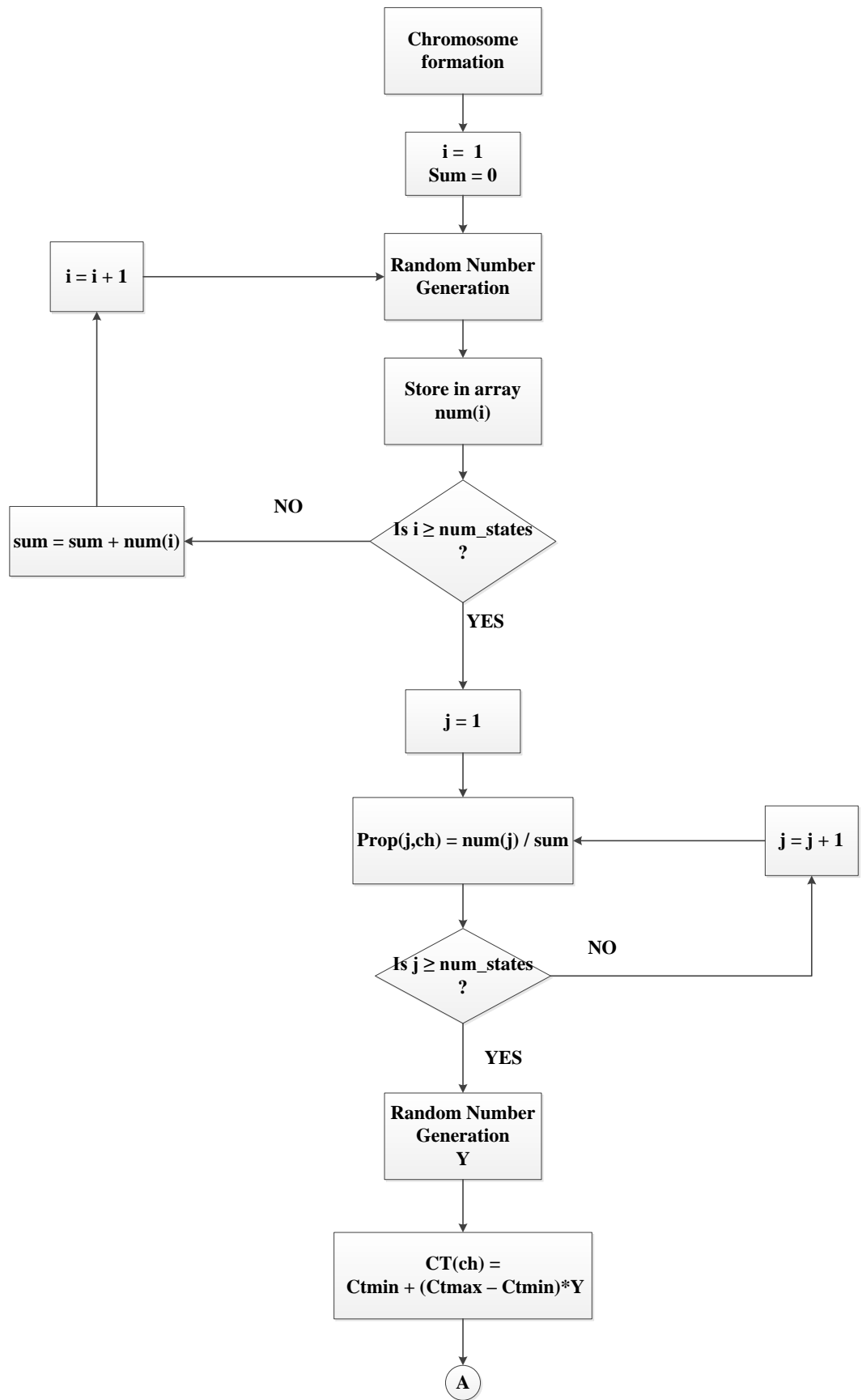

Figure 4-13: Chromosome formation procedure in the GA code

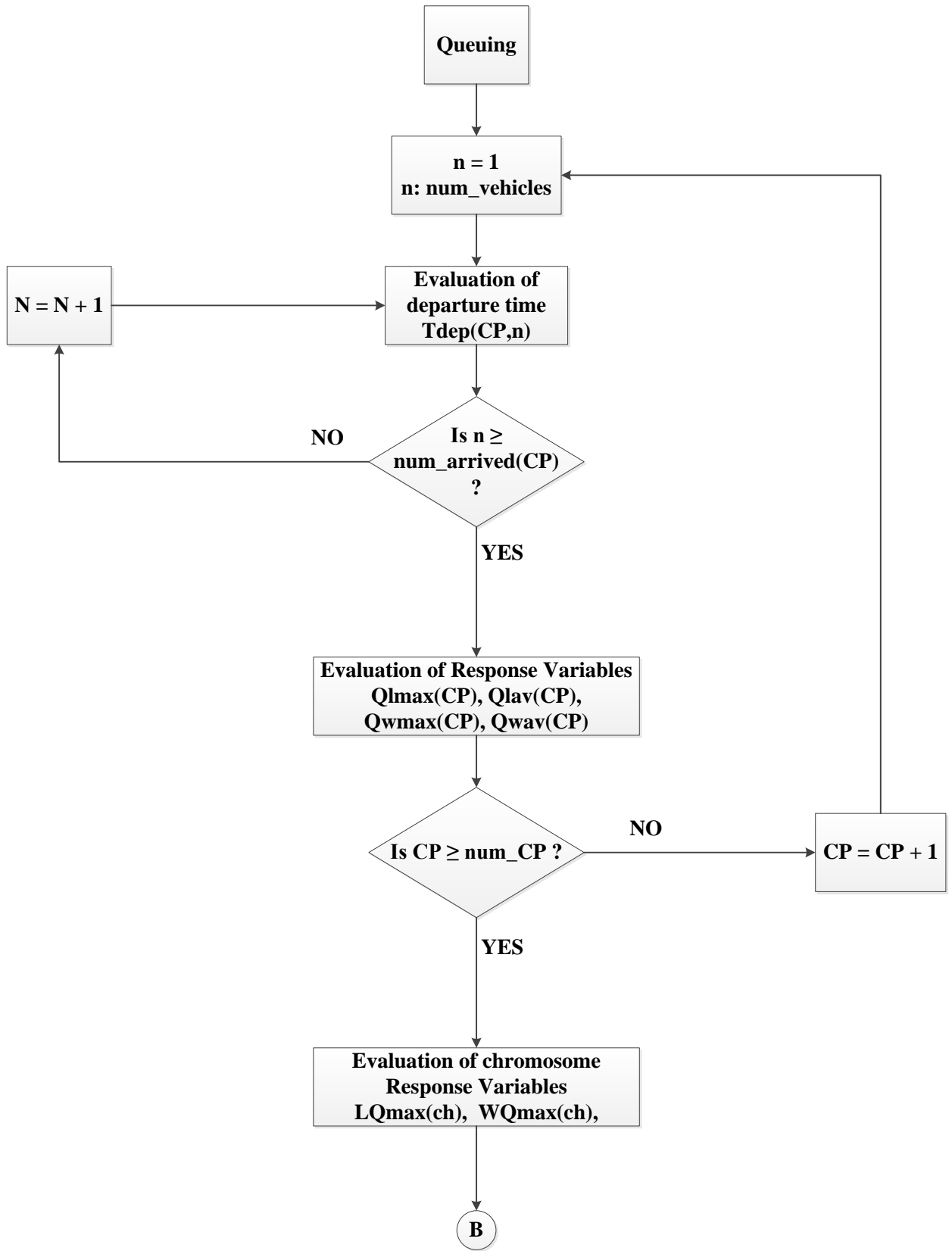

Figure 4-14: Queuing procedure in the GA code

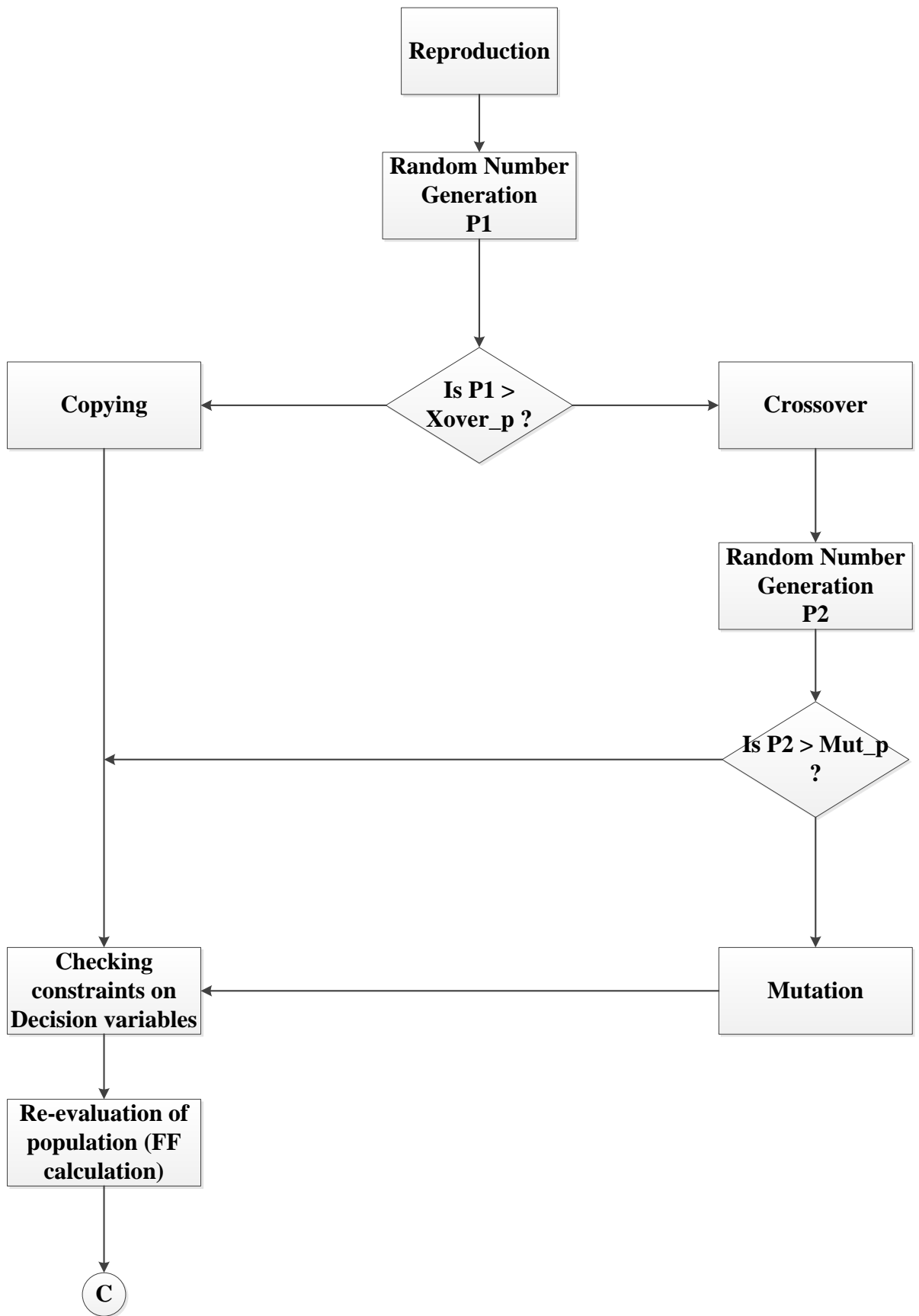

Figure 4-15: Reproduction procedure in the G.A code

- **Program infrastructure and flow chart interpretation**

The sequence of the developed program shown in the flowchart can be summarized in the following steps (accompanied with snapshots representing major parts of the developed code).

### **Reading Input Data (Data Enter)**

This step shown in Figure 4-16 includes reading the input data, either directly entered to the program, or from the accompanying excel sheet. Input data includes the number of periods to be studied per run, number of control points, number of states, the phase plan, the periods' time intervals, the arrival rates, dissipation rates and the cycle time range.

```
Public Sub Data_Enter()  
Worksheets("Sheet1").Select  
num_periods = 1  
num_CP = 2  
num_states = 2  
  
'phase plan enter  
State(1, 1) = 1: State(1, 2) = 0  
State(2, 1) = 0: State(2, 2) = 1  
  
For a = 1 To num_periods  
period(a) = Cells(4, a + 1)  
Next a  
  
For b = 1 To num_CP  
For c = 1 To num_periods  
Arr_rate(b, c) = Cells(b + 1, c + 1)  
Next c  
Next b  
  
For f = 1 To num_CP  
For g = 1 To num_periods  
inter_delay(f, g) = Cells(f + 9, g + 1)  
Next g  
Next f  
  
For h = 1 To num_periods  
CTmax(h) = Cells(6, h + 1)  
CTmin(h) = Cells(5, h + 1)  
Next h
```

**Figure 4-16: Data Enter procedure**

### **Simulation of Car Arrivals**

For each control point, vehicles' arrivals are simulated using the exponential distribution for the time between arrivals as shown in Figure 4-17 (simplifying assumption that is quite close to reality). The arrivals of cars continue in the control point until the arrival time of the last vehicle equals the time interval of the period in study. At that point, the number of arrived cars is recorded in an array.

```

For d = 1 To num_CP
For e = 1 To num_periods
m = 1
TArriv(d, e, m) = 0
Randomize
Do
m = m + 1
XX = Rnd
TArriv(d, e, m) = TArriv(d, e, m - 1) + 1 + ((1 / Arr_rate(d, e)) * (Log(1 / (1 - XX))))
Loop Until TArriv(d, e, m) >= period(e) + 1
num_arrived(d, e) = m
Cells(10, 11) = m
Next e
Next d

```

Figure 4-17: Vehicles' simulation in G.A. code

## Specification of G.A parameters

In this step, the parameters of the GA are defined. These are the population size, the desired number of generations, and the crossover and mutation probabilities.

```

pop_size = 50
num_generations = 100
xover_p = 0.95
mut_p = 0.1
|
End Sub

```

Figure 4-18: Specification of G.A parameters in G.A code

## Chromosome formation: Building population

Here, the chromosome is built up as in Figure 4-19. As mentioned earlier, the chromosome consists of state proportions, together with the cycle time.

```

Public Sub chromosome(ch)
Dim x(10)
Dim randomvalue As Integer
For i = 1 To num_periods
Randomize
sum = 0
For j = 1 To num_states
'randomvalue = CInt(Int((20 - 10) * Rnd() + 10)) 'added to guarantee the state timing will be large enough
'x(j) = randomvalue / 20
x(j) = Rnd
sum = sum + x(j)
Next j
For k = 1 To num_states
prop(k, i, ch) = x(k) / sum
proportion(k, i) = prop(k, i, ch)
Next k
y = Rnd
CT(i, ch) = CTmin(i) + (CTmax(i) - CTmin(i)) * y
CTq(i) = CT(i, ch)
Next i

```

Figure 4-19: Chromosome formation in G.A code

## Queuing

This step represents the queuing process that takes place throughout the system. Based on the time of arrival of each vehicle and the phase plan sequence, the departure timings can be calculated. Having the arrival and departure timings, the response variables can be easily evaluated. These include the maximum and average queue lengths & waiting times for each control point as shown in Figure 4-20.

```
Public Sub Queuing(q)
n = 1 'cars
p = 1 'multiples of interdelay
num_cyc = 1 ' number of cycles
Dim val1, val2

If CP = 1 Then
Do
Cells(n, 10) = TArriv(1, q, n)
Tstartgreen = (num_cyc - 1) * CTq(q)
Tendgreen = Tstartgreen + (proportion(1, q) * CTq(q))
If TArriv(1, q, n) < Tendgreen Then
val1 = Tstartgreen + (p - 1) * inter_delay(1, q)
val2 = TArriv(1, q, n)
If val1 >= val2 Then
Tdep(1, q, n) = val1
Else: Tdep(1, q, n) = val2
End If
Cells(n, 11) = Tdep(1, q, n)
n = n + 1
p = p + 1
Else: num_cyc = num_cyc + 1
p = 1
End If
Loop Until n = num_arrived(1, q) + 1

Else 'if CP=2
Do
Cells(n, 13) = TArriv(2, q, n)
Tstartgreen = ((num_cyc - 1) * CTq(q)) + (proportion(1, q) * CTq(q))
Tendgreen = Tstartgreen + (proportion(2, q) * CTq(q))
If TArriv(2, q, n) < Tendgreen Then
val3 = Tstartgreen + (p - 1) * inter_delay(2, q)
val4 = TArriv(2, q, n)
If val3 >= val4 Then
Tdep(2, q, n) = val3
```

Figure 4-20: Queuing in G.A code



```

Public Sub GetMaxQL(r)
arr = 1
dep = 1
sumQ = 0
Qmax = 0
Q1 = 0
Do
If TArriv(CP, r, arr) = Tdep(CP, r, dep) Then
arr = arr + 1
dep = dep + 1
If Q1 > Qmax Then
Qmax = Q1
End If

ElseIf TArriv(CP, r, arr) < Tdep(CP, r, dep) Then
Q1 = Q1 + 1
arr = arr + 1
sumQ = sumQ + Q1
If Q1 > Qmax Then
Qmax = Q1
End If

Else
Q1 = Q1 - 1
dep = dep + 1
sumQ = sumQ + Q1
If Q1 > Qmax Then
Qmax = Q1
End If
End If
Loop Until arr = num_arrived(CP, r)
QL_max = Qmax
QL_av = sumQ / arr
Cells(7, 7) = QL_max
Cells(7, 8) = QL_av
End Sub

```

**Figure 4-21: Queuing (2) in G.A. code**

```

Public Sub GetMaxQW(s)
sumQW = 0
Wmax = 0
QW = 0
t = 1
If CP = 1 Then
Do
QW = Tdep(CP, s, t) - TArriv(CP, s, t)
Cells(t, 12) = QW
If QW > Wmax Then
Wmax = QW
End If
t = t + 1
sumQW = sumQW + QW
Loop Until t = num_arrived(CP, s)
QW_max = Wmax
QW_av = sumQW / t

Else 'CP=2
Do
QW = Tdep(CP, s, t) - TArriv(CP, s, t)
Cells(t, 15) = QW
If QW > Wmax Then
Wmax = QW
End If
t = t + 1
sumQW = sumQW + QW
Loop Until t = num_arrived(CP, s)

```

**Figure 4-22: Queuing (3) in G.A. code**

## Population evaluation: Fitness Function calculation

Now that we have the values of the response values for each control point in a chromosome, the maximum queue length and waiting time among the different control points is stored in an array. The fitness function of the chromosome is calculated as follows:

$$\text{Fitness Function } z_n = (LQ_{max} * WQ_{max})_n$$

where  $n$  : the chromosome's index ranging from 1 to population size

Note that the maximum queue length for a chromosome used in the FF is the maximum of the maximum queue length among the different control points, and same applies to the maximum waiting times.

Then, the process is repeated on all chromosomes in order to evaluate the fitness function of each chromosome as shown in Figures 4-23, 4-24.

```
Public Sub GetMax_GenQL(chr) 'max queue length in a chromosome .. because a chromosome contains a max queue length for each control point
Dim GenQL(10)
Dim tempoval

For u = 1 To num_CP
GenQL(u) = QLmax(u, 1, chr)
Next u

'must do bubble sorting
For uu = 1 To num_CP - 1
tempoval = GenQL(uu)
For uuu = 1 To num_CP - uu
If GenQL(uuu + uu) > tempoval Then
GenQL(uu) = GenQL(uuu + uu)
GenQL(uuu + uu) = tempoval
tempoval = GenQL(uu)
End If
Next uuu
Next uu
Gen_QL = GenQL(1)
End Sub

Public Sub GetMax_GenQW(cch)
Dim GenQW(10)
Dim tempoval
For u = 1 To num_CP
GenQW(u) = QWmax(u, 1, cch)
Next u

For uu = 1 To num_CP
tempoval = GenQW(uu)
For uuu = 1 To num_CP - uu
If GenQW(uuu + uu) > tempoval Then
```

Figure 4-23: Fitness function calculation

```

GetMax_GenQL (ch)
Gener_QL(ch) = Gen_QL
GetMax_GenQW (ch)
Gener_QW(ch) = Gen_QW
YFit(ch) = Gen_QL * Gen_QW
End Sub

```

Figure 4-24: Fitness function calculation (2)

## Generation Sorting & Selection

Then, the population is sorted in an ascending order. This is because in this experiment, the smaller the value of the fitness function, the better it is.

After that, two chromosomes are selected as in Figure 4-25 and 4-26 to pursue with the reproduction process.

```

Public Sub Generation_Sort()
Worksheets("Sheet2").Select
Dim normfit(100) As Single

For v = 1 To (pop_size - 1)
tempval = YFit(v)
tempindex = Label(v)
    For w = 1 To (pop_size - v)
        If YFit(w + v) < tempval Then
            YFit(v) = YFit(w + v)
            Label(v) = Label(w + v)
            YFit(w + v) = tempval
            Label(w + v) = tempindex
            tempval = YFit(v)
            tempindex = Label(v)
        End If
    Next w
Next v

```

Figure 4-25: Generation sorting in G.A code

```

For x = 1 To pop_size
Cells(x, 2) = Label(x)
Cells(x, 3) = YFit(x)
Next x

Cells(1, 1) = 0
sum1 = 0
For x = 1 To pop_size
sum1 = sum1 + YFit(x)
Next x
sumfit = sum1

For y = 1 To pop_size
normfit(y) = YFit(y) / sumfit
Next y

sum2 = 0

For Z = 1 To pop_size
sum2 = sum2 + normfit(Z)
Cells(Z + 1, 1) = sum2
Next Z

myrange = Range("A1:B50")
For aa = 1 To 2
bb = Rnd
candidate(aa) = Application.WorksheetFunction.VLookup(bb, myrange, 2, True)
Next aa

End Sub

```

**Figure 4-26: Selection in G.A code**

## Reproduction

This process is one of the crucial processes in a G.A Experiment because it ensures the overall improvement and evolution of the population. Based on specified probabilities, either crossover or copying takes place (with very large weight assigned to crossover compared to copying). Crossover is the process of mating the chromosomes to produce a better generation of children than the mating parents.

Copying is the process of replacing the selected candidates with the worst chromosomes in the population. After that, comes the mutation process. Mutation is specified by a relatively low percentage. It is used in order to open up new field of search and avoid the local optima dilemma. Then, the pre-specified constraints are checked in order to ensure that feasible solutions are attained. After creating a new population of children, the chromosomes are re-evaluated, the generation is re-sorted and selection of new candidates takes place. The process is repeated until meeting the specified ending criteria as shown in Figure 4-27 and 4-28.

```

If yy <= xover_p Then
optem(1) = candidate(1)
optem(2) = candidate(2)
worst(1) = Label(pop_size - 1)
worst(2) = Label(pop_size)

For bb = 1 To 2
Randomize
yy = Rnd
If yy <= 0.5 Then
CT(1, worst(bb)) = CT(1, optem(bb))
CTq(1) = CT(1, worst(bb))
Else
If bb = 1 Then xch = 2 Else xch = 1
CT(1, worst(bb)) = CT(1, optem(xch))
CTq(1) = CT(1, worst(bb))
End If

```

**Figure 4-27: Crossover in G.A code**

```

For hh = 1 To 2
CT(1, worst(hh)) = CT(1, optem(hh))
CTq(1) = CT(1, worst(hh))
For ii = 1 To num_states
prop(ii, 1, worst(hh)) = prop(ii, 1, optem(hh))
proportion(ii, 1) = prop(ii, 1, worst(hh))
Next ii

```

**Figure 4-28: Copying in G.A code**

## **Printing out the results & analysing**

After meeting the specified criteria, the results are printed on an excel sheet for further analysis as shown in Figure 4-29 and 4-30.

```

Worksheets("Sheet3").Select
For jj = 1 To 2
Cells(jj + 1, 1) = Label(jj)
Cells(jj + 1, 2) = CT(1, Label(jj))
Cells(jj + 1, 3) = prop(1, 1, Label(jj))
Cells(jj + 1, 4) = prop(2, 1, Label(jj))
Cells(jj + 1, 5) = prop(3, 1, Label(jj))
Cells(jj + 1, 9) = YFit(Label(jj))
Cells(jj + 1, 10) = QLmax(1, 1, Label(jj))
Cells(jj + 1, 11) = QLav(1, 1, Label(jj))
Cells(jj + 1, 12) = QLmax(2, 1, Label(jj))
Cells(jj + 1, 13) = QLav(2, 1, Label(jj))
Cells(jj + 1, 14) = QLmax(3, 1, Label(jj))
Cells(jj + 1, 15) = QLav(3, 1, Label(jj))
Cells(jj + 1, 16) = QLmax(4, 1, Label(jj))
Cells(jj + 1, 17) = QLav(4, 1, Label(jj))
Cells(jj + 1, 18) = QWmax(1, 1, Label(jj))
Cells(jj + 1, 19) = QWav(1, 1, Label(jj))
Cells(jj + 1, 20) = QWmax(2, 1, Label(jj))
Cells(jj + 1, 21) = QWav(2, 1, Label(jj))
Cells(jj + 1, 22) = QWmax(3, 1, Label(jj))
Cells(jj + 1, 23) = QWav(3, 1, Label(jj))
Cells(jj + 1, 24) = QWmax(4, 1, Label(jj))
Cells(jj + 1, 25) = QWav(4, 1, Label(jj))
Next jj
End Sub

```

Figure 4-29: Printing results in G.A code

	A	B	C	D	E	F	G	H	I	J	K	L	M	N	O	P	Q	R	S	T	U
1	Chrom	CT	prop1	prop2	prop3	TA	TB	TC	YFIT	QLmax 1	Qlav 1	QLmax 2	Qlav 2	QLmax 3	Qlav 3	QLmax 4	Qlav 4	QWmax 1	QWav 1	QWmax 2	QWav 2
2	19	77.92892	0.482677	0.293908	0.223416	37.61446	22.9039	17.41055	847.2571	14	4.562216	9	3.348804	13	3.495835	9	3.643305	40.30978	10.65797	54.98212	19.80
3	12	77.92892	0.482677	0.293908	0.223416	37.61446	22.9039	17.41055	847.2571	14	4.562216	9	3.348804	13	3.495835	9	3.643305	40.30978	10.65797	54.98212	19.80
4																					
5																					
6																					

Figure 4-30: Printing results in G.A code (2)

## F. G.A Experimentation & Results

Now that the program is running successfully, experimentation is carried out to render the optimized decision variables. The GA optimization is applied on both intersection 1 and 2 for the pre-specified periods of the day.

Table 4-9 represents the G.A optimized state timings and cycle time during different periods of the day in intersection 1 and 2.

**Table 4-9: G.A results**

			Period				
Int.	State	Timing	7-9am	9-1pm	1-5pm	5-11pm	11-7am
2	A	$T_A$	80	65	70	65	40
	B	$T_B$	40	35	50	35	20
	C	$T_C$	20	20	20	25	20
	Cycle time		140	120	140	125	80
1	A'	$T_{A'}$	45	35	45	35	20
	B'	$T_{B'}$	55	45	55	45	25
	Cycle time		100	80	100	80	45

The red and green timings displayed on the light signal can be deduced from the optimized state timings as shown in Table 4-10:

**Table 4-10: red and green signals based on G.A optimized timings**

			Period				
Int.	C.Point	Timing	7-9am	9-1pm	1-5pm	5-11pm	11-7am
2	1	$T_{G_1}, TR_1$	80,60	65,55	70,70	65,60	40,40
	2	$T_{G_2}, TR_2$	40,100	35,85	50,90	35,90	20,60
	3	$T_{G_3}, TR_3$	60,80	55,65	70,70	60,65	40,40
	4	$T_{G_4}, TR_4$	20,120	20,100	20,120	25,100	20,60
Cycle time			140	120	140	125	80
1	1'	$T_{G_{1'}}, TR_{1'}$	45,55	35,45	45,55	35,45	20,25
	2'	$T_{G_{2'}}, TR_{2'}$	55,45	45,35	55,45	45,35	25,20
	Cycle time			100	80	100	80

#### 4.4 EXTENDSIM8 SIMULATION OF G.A OPTIMIZED TIMINGS

Simulation is a powerful tool to represent the system, analyse and improve its performance. Simulation steps and procedures using Extendsim8 will be discussed in detail in chapters V through VIII. In subsequent chapters, different simulation models and scenarios are developed to accurately represent the system. The G.A optimized timings are entered into the simulation model to visualize the performance of the system, demonstrate the improvement (if any). Table 4-11 shows the simulation results.

**Table 4-11: Simulation results of G.A. optimized timings**

		Period									
		7-9am		9-1pm		1-5pm		5-11pm		11-7am	
Int	CP.	$LQ_{av}$	$WQ_{av}$	$LQ_{av}$	$WQ_{av}$	$LQ_{av}$	$WQ_{av}$	$LQ_{av}$	$WQ_{av}$	$LQ_{av}$	$WQ_{av}$
2	1 B1	1.6	5	1.2	4	6	17	0.2	2	0.02	0.001
	1 B2	1.23	4.6	1	4	3	13	1	2	0.01	0.01
	1 both	10.4	17	10	17	15	22	7	19	3	10
	2	20	46	15	38	15	36	10	37	2	22
	3	12	24	8	19	11	20	6	18	1.13	7
	4	4	24	3	20	5	25	2.5	20	0.6	11
1	1'	5	11	5	12	7	15	3	9	1	4
	2'	7	26	3	14	5	20	3	16	0.7	7

#### 4.5 CONCLUSIONS & RECOMMENDATIONS

The results shown above are compared to the performance of the actual performance which is also simulated using Extendsim8 (carried out in subsequent chapters). The simulation steps and procedures are discussed in detail in subsequent chapters. However, it is strongly recommended to carry out a comparison between the performance of the actual system using the currently used signal timings vs. the G.A. optimized signal timings results obtained by G.A. experiment and visualized using Extendsim8 simulation.



Charts 4-31, 4-32 and 4-33 indicate the improvement that has taken place in different periods of the day in both intersections (1 and 2) due to the G.A optimization of traffic signal timings.

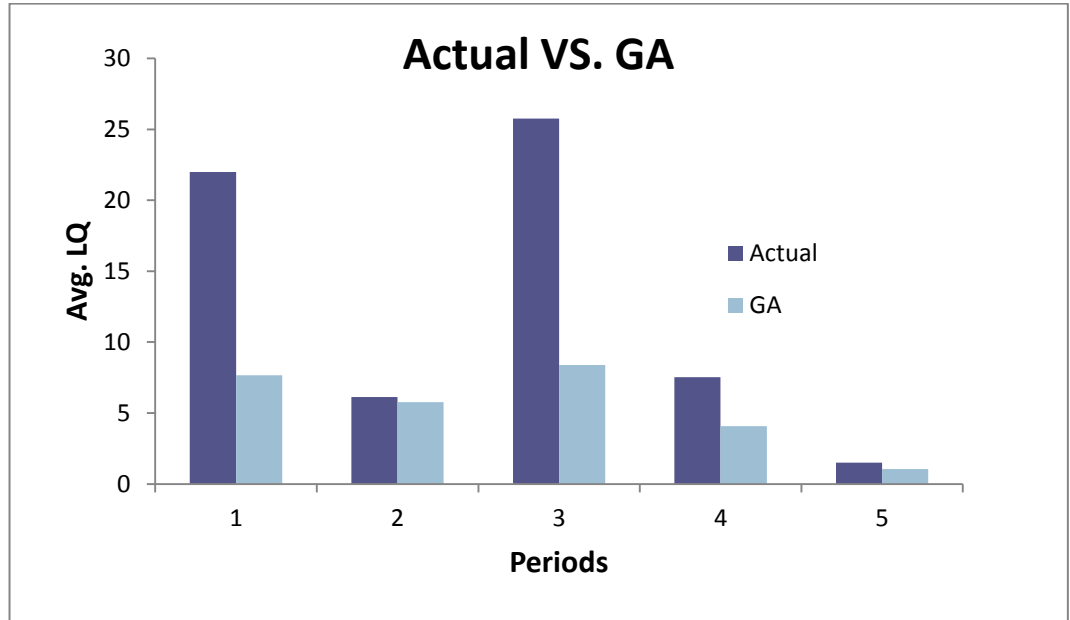

Figure 4-31: Chart comparing the actual vs. G.A model in terms of LQav

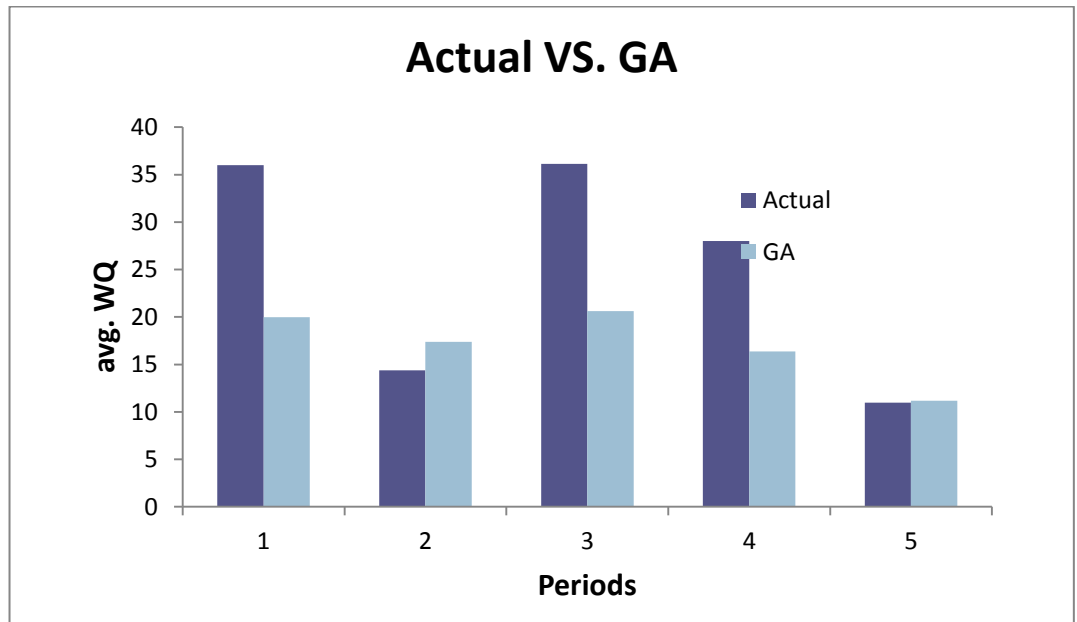

Figure 4-32: Chart comparing the actual vs. GA model in terms of WQav

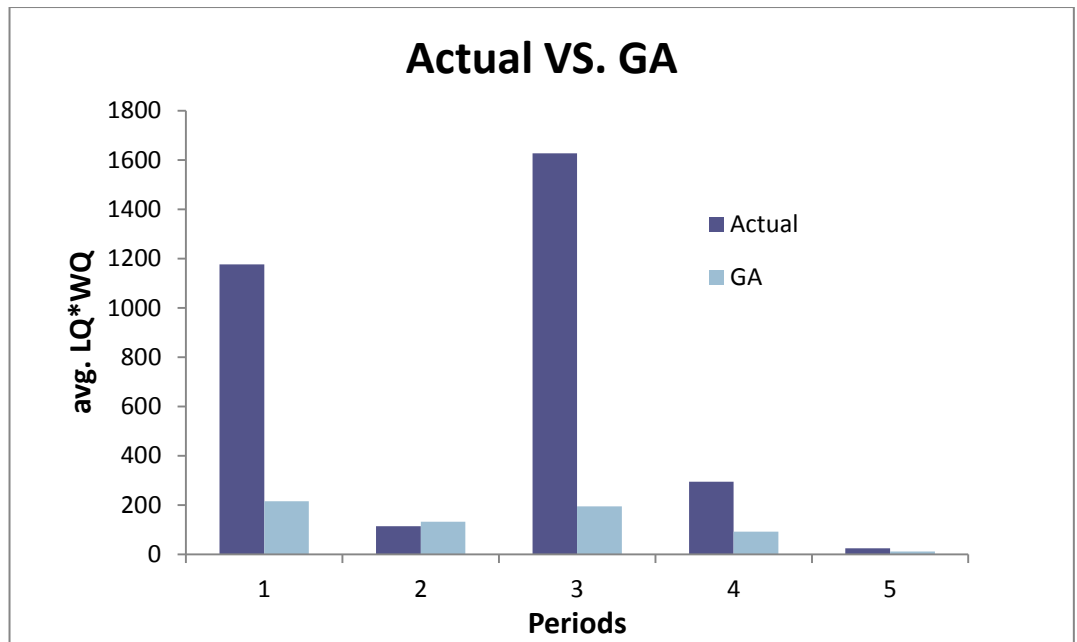

Figure 4-33: Chart comparing the actual vs. GA model in terms of  $LQ_{av} * WQ_{av}$

Hence, the overall percentage improvement can be easily evaluated for both average queue length and average waiting time using the following equation:

**Percentage reduction in Average queue length over all periods :**

$$\% \text{ reduction in } LQ_{av} = \frac{LQ_{av1} - LQ_{av2}}{LQ_{av1}} \cong 43\%$$

The average queue length in both intersections 1 and 2 has decreased by approximately **43%**.

**Percentage reduction in Average waiting time over all periods:**

$$\% \text{ reduction in } WQ_{av} = \frac{WQ_{av1} - WQ_{av2}}{WQ_{av1}} \cong 30.2\%$$

The average waiting time of intersections 1 and 2 has decreased by approximately **30.2%**.

**Recommendations**

It will remarkable that the results are encouraging and positively reflect the success of the G.A experiment that is conducted to optimize the traffic signal timings for the purpose of solving the problem of traffic congestion.

Therefore, it is strongly recommended to:

- Implement the G.A. optimized timings in the real world system through coordination with traffic control department in the city to ensure that the results are reliable and effective.
- In case of the success of the implementation phase, it is strongly recommended to apply this experiment on various critical intersections in Alexandria, Egypt in order to generalize the success and cut off one of the main problems that threatens the splendour of this beautiful city.

## **5 MODELING AND SIMULATION OF THE ACTUAL SYSTEM**

### **5.1 INTRODUCTION TO COMPUTER SIMULATION**

Many researchers and engineers face major problems in their systems, restricting the opportunities to satisfy their specified objectives and goals. Those problems need to be attended to. Sometimes they are quite simple, hence they can be solved mathematically and analytically. However, quite frequently and in the case of real systems, those problems offer a great degree of complexity, where the analytical solution cannot be applicable. As a result, simulation arises.

Simulation mimics the operations of a system or process, and experiments by changing conditions and variables within the system to understand how it behaves, and how those alterations will impact it.

The simulation of traffic and transportation systems has started over 40 years ago, and is an important area of discipline in Traffic engineering nowadays. During those forty years, computer simulation has developed from a research tool of limited group experts, to a widely used technology in the exploration, planning, designing, operating and improvement of traffic and transportation systems. Simulation is now an everyday tool for researchers and practitioners in all fields of the profession.

Simulation used in the fields of traffic is significant as it can study models that are too problematic for analytical treatment, it can be used for experimental studies on a traffic system, and to produce visual demonstrations of both present and future scenarios for the traffic system.

Referring back to the literature review chapter, many reports, articles and conference papers have been read and documented during the course of this project. 60% of those references were classified according to the topic of simulation of traffic systems and optimization using simulation. This is evidence enough that many researchers have

applied simulation to the problem of traffic light signal timings, in the attempt to optimize the traffic light signal timings using specified decision criteria.

## **5.2 EXTENDSIM 8: SIMULATION SOFTWARE PACKAGE**

Software applications that support simulation have recently grown, as the demand for simulation is increasing, replacing all the traditional analytical solutions.

The ExtendSim8 software package has been carefully chosen to be used to perform all the traffic system simulations, and for the optimization of the traffic light signals in this project.

The ExtendSim package on the contrary is an easy to use, yet powerful tool when it comes to simulation. Its environment provides the tools for all level of modelers to efficiently create accurate, credible and usable models. The ExtendSim facilitates every step of the simulation to be carried out in this simulation study, ranging from creation, to validating and verifying the model, to the construction of a user interface that allows easy analysis of the system.

ExtendSim models are built using library based iconic blocks, where each block represents a step or calculation in the model. The software has a drag and drop interface creation, where the blocks are placed on the model by dragging them from the library window, and a flow is then established between the blocks. The blocks are all very easily understood and applied, in order to model very complex systems.

In addition, the ExtendSim package provides a suite for communication tools allowing communication with external programs such as Microsoft Excel. It also facilitates an evolutionary optimizer which employs powerful algorithms to determine the best model configuration, and offers options for automatic automations and debugging tools, which all aid in validating and verifying a model, and makes it easy for the modeler to see how the model is operating.

## **5.3 REVIEW ON SIMULATION STEPS**

For any simulation study, there should be a set of steps and techniques to be followed and applied as shown in Figure 5-1, to guide the analyst in creating a valid model and

eventually solving the desired problem. Those steps were discussed in the literature review chapter and are listed below. They have been followed through the entire simulation modeling of the traffic system. Their application is described later on in this chapter.

**Problem Formulation:** Enumerate and define the dilemma and the required objectives clearly.

**Modelling:** The construction of a model of the system by defining the decision variables, the objective function and the feasible constraints that regulate and limit these variables.

**Data collection:** The collection of the data essential to activate the model. The more the data is accurate, the more reliable and confident the results are.

**Model translation:** Entering the model to the computer simulation software.

**Model verification:** Checking whether the input parameters and the logical structure of the model entered in the computer replicates the real system or not. If not, the model translation process is revised for further adjustments. Comparisons of the outputs from the model and the actual system are carefully made, and repetition of this process is essential for accuracy.

**Simulation Experiment/ Calibration:** An iterative process in which the model is run at exactly the same actual conditions of the system, and the output results are compared with the real system behaviour.

**Validation:** If the calibration results are odd, then there is something wrong with either the modelling phase or the data collected, otherwise the sequence is continued.

**Simulation runs:** To run the simulation model with the alternative solutions suggested, and analyse the results to estimate the system performance.

**More runs:** To check if the model needs further runs to present reliable, confident output.

**Documentation and reporting:** A final report about the simulation process must be presented to clarify the results and add credibility to the model-building process.

**Implementation:** Implementing what happened in the simulation on the real system.

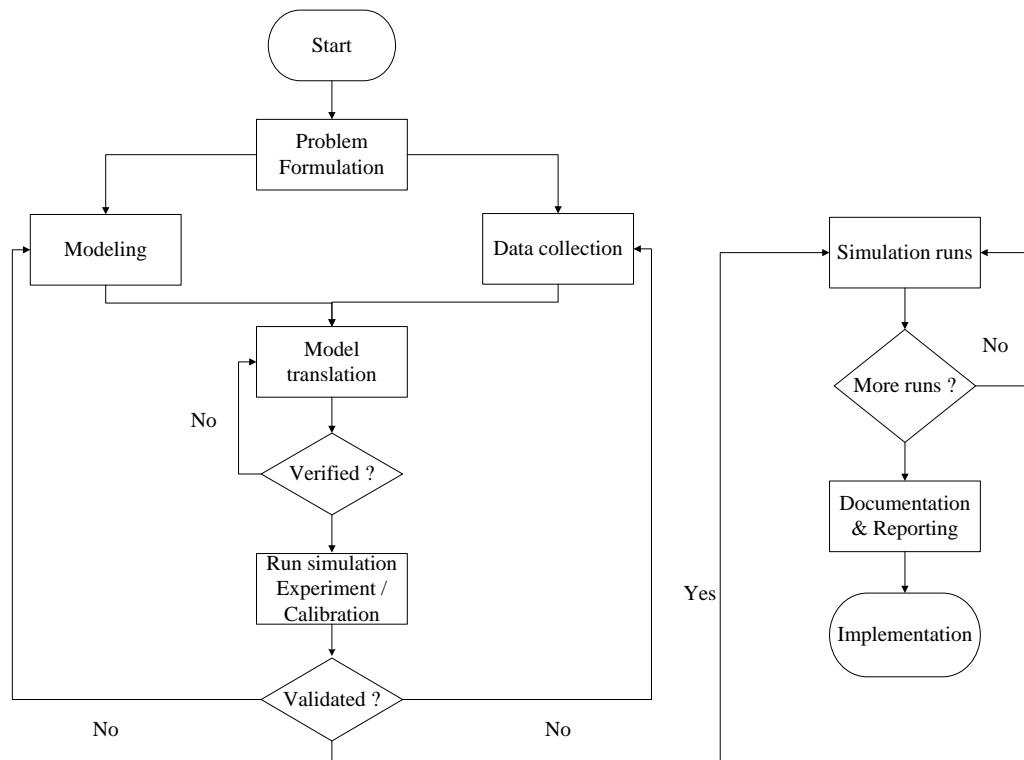

**Figure 5-1: Simulation Steps**

### 5.3.1 Step 1: Problem formulation

The first step in the simulation study is the problem formulation. This step requires stating and describing the problem at hand, as well as enumerating the aims and objectives of the study. Assumptions and objectives can be made and modified throughout the course of the traffic system study.

The problem at hand is the massive inflation of the vehicles' queue lengths and the waiting times throughout Alexandria, as a result of the lack of a reliable control policy that regulates the traffic signal lights. Through field observation, the signal light timings were found to be fixed through all the periods of the day, which does not correspond to the randomness of the time-fluctuating demand of vehicles.

The main aim of this simulation study is to create a simulation model that accurately represents the actual system under study, and suggest better scenarios to improve the performance and cut off the traffic congestion problem.

### 5.3.2 Step 2: Modelling

This is the second step in the simulation study. It refers to the formulation of an analytical model of the system by defining the decision variables, the objective function and the feasible constraints that regulate and limit these variables.

The step of model formulation was completely accomplished in chapter V. A quick summary of the model formulation is as follows:

#### A. Decision Variables

$T_{ik}$  : State timing in intersection ( $j$ ), where  $i = \{A, B, C, \dots, N\}$ ,  $k = \{1, 2, 3, \dots, l\}$

$CT_k$  : Cycle time of the intersection, where  $CT_k = \sum_{i=A}^N T_i$

#### B. System parameters

- **Arrival rates (vehicles/sec)**

$\lambda_{jk}$  : Arrival rate at Control Point ( $j$ ) in intersection ( $k$ ),  
where  $j = \{1, 2, \dots, M\}$ ,  $k = \{1, 2, \dots, l\}$

- **Departure rates (vehicles/sec)**

$\mu_{jk}$  : departure rate at Control Point ( $j$ ) in intersection ( $k$ ),  
where  $j = \{1, 2, \dots, M\}$ ,  $k = \{1, 2, \dots, l\}$

- **Geometrical road capacities (vehicles)**

$L_{jk}$  : Max. Capacity of C. Pt( $j$ ) in intersection ( $k$ ), where  $j = \{1, 2, \dots, M\}$ ,  $k = \{1, 2, \dots, l\}$



### C. Response Variables

- **Queue lengths (vehicles)**

$LQ_{ik}$  : Queue length forming at control point (j) in intersection (k),

$$\text{where } j = \{1, 2, \dots, M\}, k = \{1, 2, \dots, l\}$$

- **Vehicle's Waiting time**

$WQ_{jk}$ : average waiting time of a vehicle at control point (j) in intersection (k),

$$\text{where } j = \{1, 2, 3, \dots, M\} \& k = \{1, 2, 3, \dots, l\}$$

### D. Proposed Objective function(s)

- Min. of  $z = \text{Max} \{ \overline{LQ} \}_j$ , where  $j = \{1, 2, \dots, M\}$
- Min. of  $z = \sum_{j=1}^M (\overline{LQ} * w)_j$ , where  $j = \{1, 2, \dots, M\}$ ,  $w$ : estimated weight  $\leq 1$
- Min. of  $z = \text{Max} \{ WQ \}_j$ , where  $j = \{1, 2, \dots, M\}$
- Min. of  $z = \text{Max} \{ LQ * WQ \}_j$ , where  $j = \{1, 2, \dots, M\}$
- Max.  $z = (\sum_{j=1}^M \frac{\overline{TS}_{jk}}{\overline{TS}_{jk}}) * \frac{1}{M}$

Where:

$$j = \{1, 2, \dots, M\} \text{ and } k = \{1, 2, 3, \dots, l\}$$

$$\overline{TS}_{*j} = \text{best average time spent in system}$$

$$\overline{TS}_j = \text{the actual average time spent in system}$$

### E. Governing Constraints

- **Geometrical Capacity Constraint**

$$(LQ_{max})_j \leq N_j \quad \forall j, \text{ where } j = \{1, 2, \dots, M\}$$

$$(LQ_{max})_j \leq (fN)_j \quad \forall j, \text{ where } j = \{1, 2, \dots, M\}, f: \text{the safety factor } f \leq 1$$

- **Signal timings Constraint**

$$(T_{lower\ limit})_j \leq (TG, TR)_j \leq (T_{upper\ limit})_j,$$

$$where\ j = \{1, 2, \dots, M\}$$

$$(CT_{lower\ limit})_k \leq CT_k \leq (CT_{upper\ limit})_k,$$

$$where\ k = \{1, 2, \dots, l\}$$

$$(T_{lower\ limit})_j \leq (T_A + T_B) \leq (T_{upper\ limit})_j$$

### 5.3.3 Step 3: Data collection and analysis

In chapter III, data collection and analysis process was carried out successfully. The collected data is classified into two main categories as follows:

#### **Numerical data**

Numerical data is data that is measured or identified on a numerical scale. It is all the quantitative input data that describes the performance of the system that can be analyzed using statistical methods, and displayed using tables, charts, histograms, and graphs.

Numerical data patterns were presented in chapter III.

#### **Operational and structural data**

Operational and structural data describe the nature and the structure of a system. This can be in the form of layouts and sequences to describe the operation of a system.

In this step, the system is described through both a layout of the adjacent intersections being evaluated created on Microsoft Visio 2010, as well as a phase plan of the intersection which describes the transition between different states in the corresponding control points.

The layout displayed in figure 5-2 illustrates the layout of the two connected intersections, and represents the traffic flow passing through the three control points in

different directions in intersection 2, and the vehicle flow in the two control points corresponding to intersection 1.

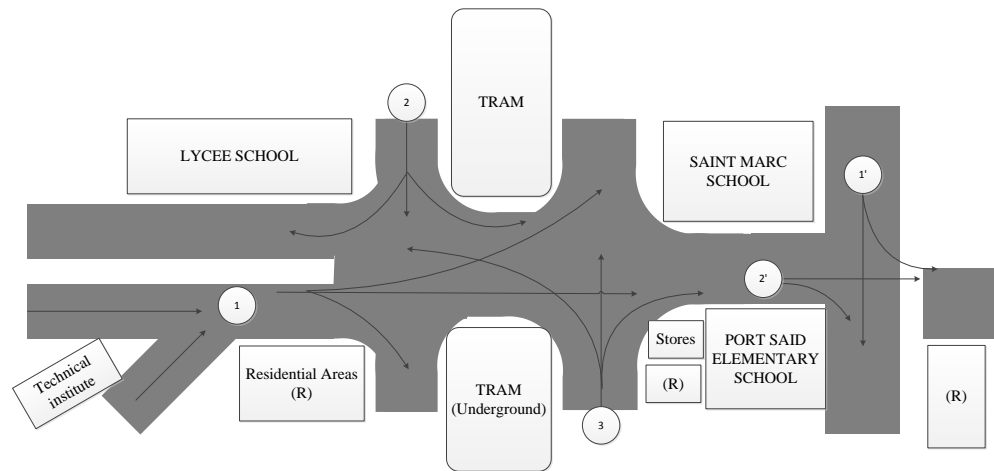

**Figure 5-2: Layout of the road network under study in simulation experimentation**

The tables below describe the phase plans, showing the different control points in their two states. Those phase plans have been discussed in greater detail in chapter 5. Reference can be made to that chapter to better understand the theory behind them.

**Actual phase plan for intersection 1:**

**Table 5-1: Actual Phase plan of intersection (1)**

State	Control Point		State timing (sec)
	1'	2'	
A'	R	G	$T_A = 50$
B'	G	R	$T_B = 60$

**Actual phase plan for intersection 2:**

**Table 5-2: Actual phase plan of intersection (2)**

State	Control Point			State timing (sec)
	1	2	3	
<b>A</b>	R	G	G	$T_A = 50$
<b>B</b>	G	R	R	$T_B = 70$

The operational sequence of traffic signalization in intersection (1) & (2) can be demonstrated using the following state diagrams shown in Figures 5-3 and 5-4:

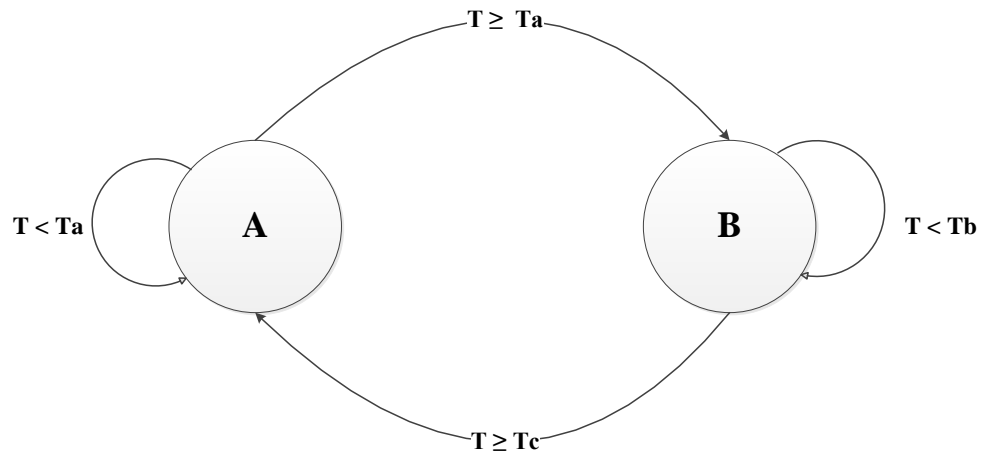

**Figure 5-3: State diagram of intersection (1)**

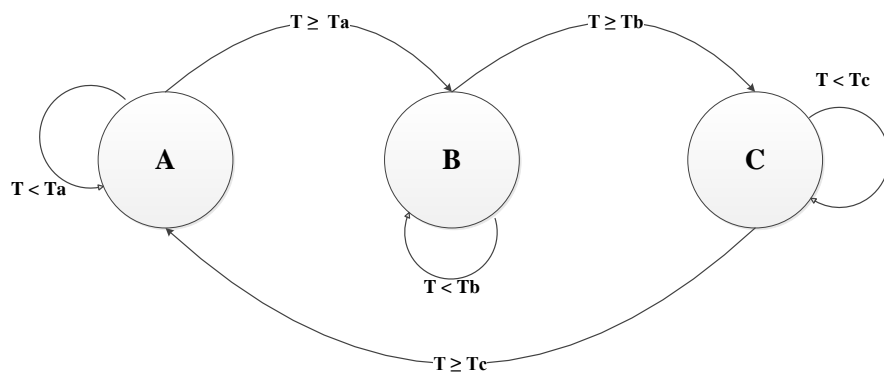

**Figure 5-4: State diagram of intersection (2)**

### 5.3.4 Step 4: Model translation

Model translation is the step of entering the model into the computer. It is the process where the model is transformed from rough ideas and formulations into computer simulation model. This section discusses the model translation of the actual traffic control system in study. The following snapshots will definitely be useful in clarifying what was achieved in model translation process.

#### Vehicular Arrivals at Control Points

Car arrivals at control points are represented as create buttons as in Figure 5-5. The create buttons generate items (vehicles) based on a random specified distribution. The time between arrivals in the illustrated control point in the snapshot is exponentially distributed. Time lookuptables are connected to the input of the create block to assign the mean of the exponential distribution of each period.

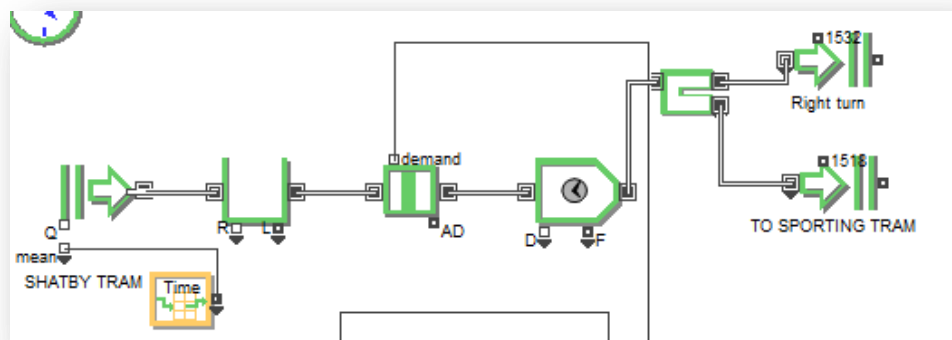

Figure 5-5: Vehicular arrivals in simulation of actual model

Each period is defined within a specified time interval, with the correspondent mean. The cycle ends at the end of the day, and then is repeated till the end of the simulation runtime.

## Queuing

A queue block follows the create block that represent the accumulation of queues. The queue block is crucial for the simulation model as all the response variables are withdrawn from it such as Average queue length and waiting time of the control point.

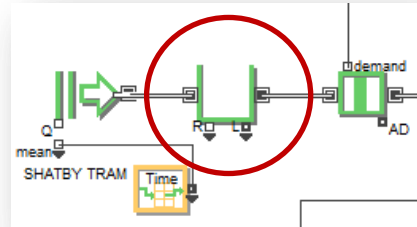

Figure 5-6: Queuing in simulation of actual model

## Signalization process

Next, comes the gate block. The gate block represents the traffic light signal. When the gate is open (having a “one” input), means green signalization, and hence vehicles are allowed to flow. Otherwise, the gate is closed (“zero” input), signifying red signalization and in turn restriction of vehicular flow.

All the gates of the model are connected to a general control lookuptable which defines the sequence of operation through the phase plan. The lookuptable controls when and how long should the gate kept open for each control point as in Figure 5-7.

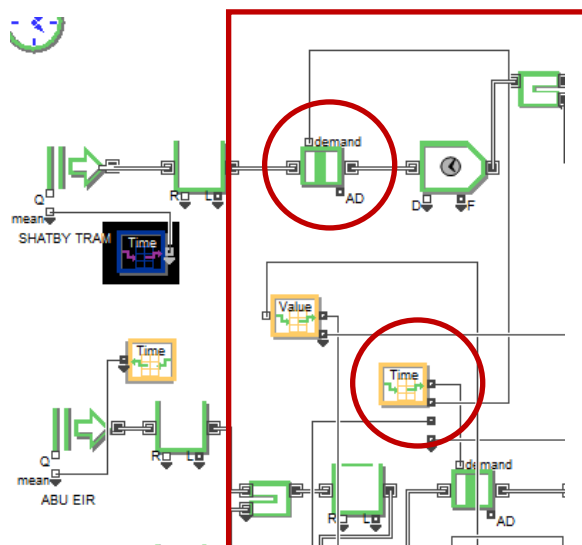

Figure 5-7: Signalization in simulation of actual model

## Inter-delay time

Right after each gate in each control point, there exist activity blocks as shown in Figure 5-8. Activity block represents the inter-delay time during vehicles' dissipation. Each control point has its own inter-delay time obtained through field measurement.

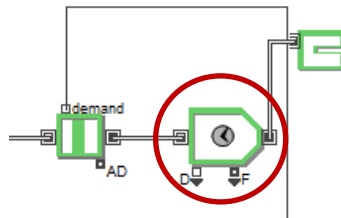

Figure 5-8: Inter-delay time in simulation of actual model

## Exiting the intersection

Then, the vehicles exit the intersection, either directly through the exit button, or through a select item out block where they decide to exit the intersection based on proportions assigned in the select item out block as in Figure 5-9.

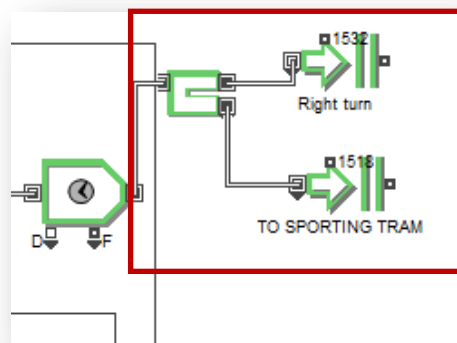

Figure 5-9: Exiting the intersection in simulation of actual model

The same procedure in building up the model applies on all the control points of the intersection, only with slight differences between a control point and another.

## Operational Sequence

Now, in order to demonstrate the rest of the blocks, it is recommended to quickly review the operational logic of the model.

The actual model is quite complex in operation, because as mentioned earlier, the phase plan is inaccurate. Thus, leading to the existence of an undefined control point which steals its state timing from the existing defined state timings.

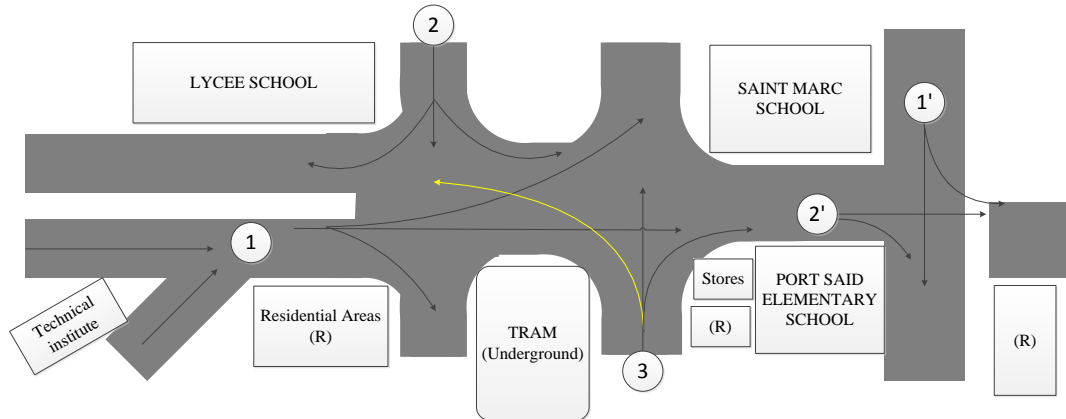

**Figure 5-10: Layout of actual system in simulation of actual model**

The actual model of intersection (2) has two states. At the beginning, state (2) takes place, giving green signalization to CP (2) & (3) while restricting the flow of CP (1). The vehicles taking the left turn from control point 3 are not assigned a signal timing. Therefore, they accumulate in the middle of the intersection during the green signalization of control point (2) & (3), and cross the road as soon as they find a chance to stop the upcoming flow from control point (2). This means they are given a green signal but with very low dissipation rates (because they wait until they find a chance to cross). Then, state transition occurs. In the second state, control point (1) is given a green signal, while CP (2) & (3) are given a red signal.

However, if there is still accumulated queue in the middle of the intersection desiring to take the left turn from the previous state, they are allowed to dissipate while holding on the emerging flow from CP (1) till the Left turn queue dissipates. This means CP (1) is given a red signal until the left turn queue dissipates, then they take a green signal. This is totally an inaccurate phase plan. However, it is the actual situation and should be modeled effectively to evaluate the current system performance. The phase plan of the actual model would be as follows:



**Table 5-3: Actual model phase plan in simulation of actual model**

State	Control Point				State timing (sec)
	1	2	3	4 (does not exist)	
<b>A</b>	R	G	G	G (with low dissipation rates)	$T_A = 50$
<b>B</b>	R(until Left turn is empty) then G	R	R	G (until the flow dissipates), then R	$T_B = 70$

This logical operation is presented in the model as in figure 5-11.

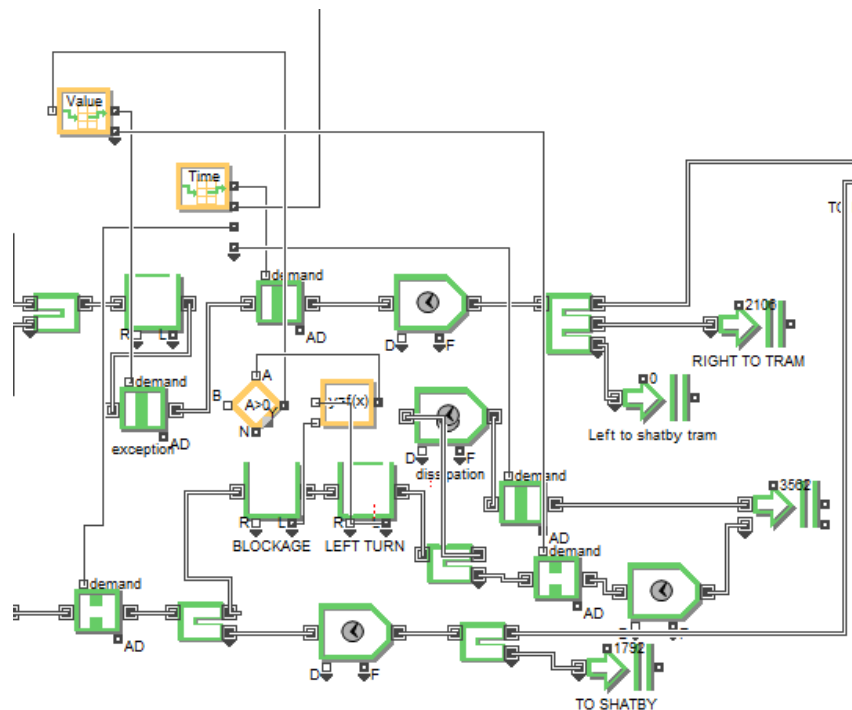

**Figure 5-11: Part of the simulation of actual model**

The first state (read from the lookuptable) gives a “zero” to CP(1) (red signal) , and ones to CP(2) and (3) (green signal).

An equation block shown in Figure 5-12 is added to calculate the queue length accumulating in the left turn queues. The output of the equation block is connected to the input of a decision (if condition) block.

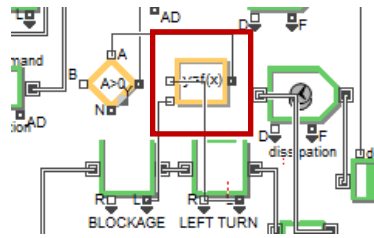

**Figure 5-12: Equation block in simulation of actual model**

The decision block determines whether the queue length in the left turn is equal to zero, or larger. If it is equal to zero, it renders a “zero”, otherwise it render a “one”. These outputs are sent to a valuelookuptable block shown in Figure 5-13.

The valuelooktable is connected to two blocks :

- Gate (A) that is in series with the gate of CP(1)
- Gate (B) that is in parallel with the gate of the left turn.

If the valuelooktable has an input of “1” (means there is a queue length in the left turn), it gives a “0” to gate (A), “1” to gate (B), and vice versa.

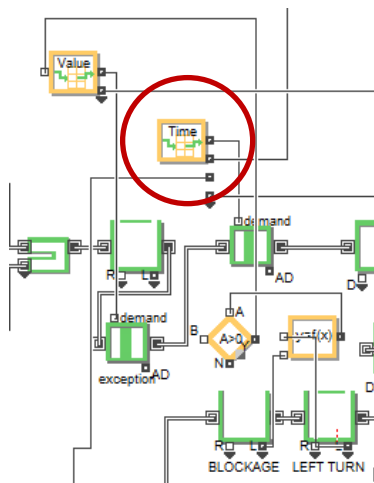

**Figure 5-13: Value lookup table in simulation of actual model**

Now let us review the different states that might take place in the intersection.

**If the intersection is in state (A) and there is a queue in the left turn:**

State (A) means that the gate of CP(1) is closed, while those of CP(2), (3), and (4) with low dissipation rate are open. Having a queue in the left turn, means that the decision block will render a “one”. When sent to the value lookuptable, This would output a “0” to Gate (A) and a “1” to gate (B).

Having two gates closed in series in CP(1), this means that the overall flow is given a red signal. CP(2) & (3) are normally given a green signal. And CP(4) will select the path of the low dissipation rate, rather than Gate(B) based on priorities set in the select item out block.

**If the intersection is in state (A) and there is no queue in the left turn.**

State (A) means that the gate of CP(1) is closed, while those of CP(2), (3), and (4) with low dissipation rate are open.

Having no queue in the left turn, means that the decision block will render a “zero”. When sent to the value lookuptable, This would output a “1” to Gate (A) and a “0” to gate (B).

Having one gate open and one closed in series in CP(1), this means that the overall flow is given a red signal. CP(2) & (3) are normally given a green signal. And CP(4) will only have the path of the low dissipation rate available.

**If the intersection is in state (B), and there is a queue in the left turn**

State (B) means that the gate of CP(1) is open, while those of CP(2), (3), and (4) with low dissipation rate are closed.

Having a queue in the left turn, means that the decision block will render a “one”. When sent to the value lookuptable, This would output a “0” to Gate (A) and a “1” to gate (B).

Having one gate open and one closed in series in CP(1), this means that the overall flow is given a red signal. CP(2) & (3) are normally given a red signal. And CP(4) will only have the path of gate (B) available.

**If the intersection is in state (B) and there is no queue in the left turn:**

Now that the queue of the left turn has totally dissipated. State (B) means that the gate of CP(1) is open, while those of CP(2), (3), and (4) with low dissipation rate are closed.

Having no queue in the left turn, means that the decision block will render a “zero”. When sent to the value lookuptable, This would output a “1” to Gate (A) and a “0” to gate (B).

Having two gates open in series in CP(1), this means that the overall flow is given a green signal. CP(2) & (3) are normally given a red signal. And CP(4) will have the gates closed.

Now, intersection 2 has been modelled successfully. Intersection 1 is much more simpler. It has its own timelookuptable block because it has its own phase plan. CP(1') in intersection(1) is modelled as all other control points.

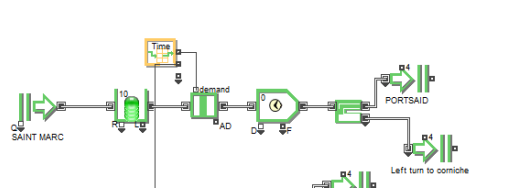

**Figure 5-14: Vehicular arrivals in intersection (1) in simulation of actual model**

CP(2') is also similarly modelled, however, the only difference that the input of vehicles into CP(2') is the sum of the exits of CP(1) and (3) of intersection (2).

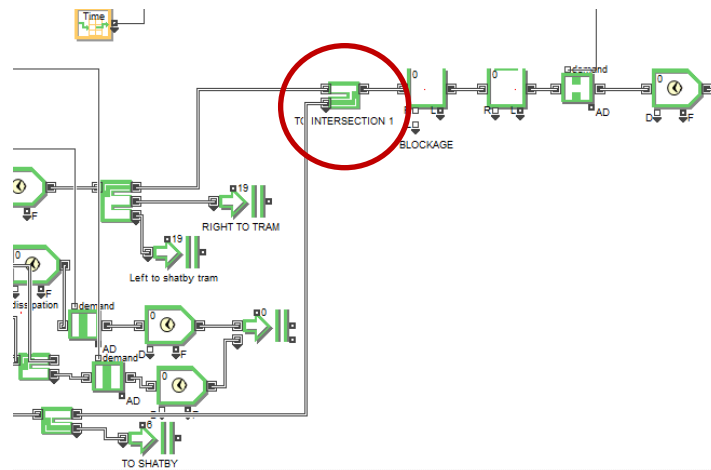

**Figure 5-15: vehicular arrivals to CP(2) in intersection (1) in actual model**

At that point, the model translation process is now completed and the model is ready for experimentation runs.

### 5.3.5 Step 5: Verification and Validation

This model was a quite complex model, and so reaching the final state of a verified and valid model, took a lot of effort and time. Verification and validation are the two processes that allow simulation analysts to reach a reliable model that truly reflects the

reality. A lot of challenges have been faced throughout the simulation process, to reach the desired operational, logical, and functional requirements.

There is a major different between the verification and validation processes. Verification is concerned with making sure that the computer model is working correctly and properly, with the right operational logic, and making comparisons with the conceptual model. The model validation ensures that the model is a real and accurate representation of the actual system, and comparisons must be made with the actual system.

### **Verification**

Throughout the modelling process, various verification steps have been carried out. Those are as follows:

- The flow of vehicles through the traffic system was monitored using the 2D animation tool in ExtendSim8 to check that the flow is behaving as intended.
- The phase plan sequence was checked to ensure that the operational logic is correctly being implemented.
- The implementation of the "if then else" conditions in the decision blocks are verified. These were checked to determine that the model acts correctly when it comes to system decisions and trade-offs.

### **Validation**

Throughout the modelling process, various validation steps have been carried out. Those are as follows:

- Using the 2D animation, detailed monitoring of every block was carried out, to ensure the correct flow of the vehicles.
- All the queue blocks were carefully tested to determine whether the model exhibits reasonable values for queue lengths and waiting times that reflect the situation of the actual model or not.
- The select items out blocks are checked throughout the model, to determine that the throughputs of each branch are behaving as specified in the proportion of each branch.

### 5.3.6 Step 6: Experimentation & Results

The actual model is run under the actual circumstances and the current state timings to evaluate the performance of the real world situation. The experimentation results are found to be close to those captured during field observation and are presented in the Table 5-4.

**Table 5-4: Results of the simulation of the actual model**

		Period									
		7-9am		9-1pm		1-5pm		5-11pm		11-7am	
Int	CP.	$LQ_{av}$	$WQ_{av}$	$LQ_{av}$	$WQ_{av}$	$LQ_{av}$	$WQ_{av}$	$LQ_{av}$	$WQ_{av}$	$LQ_{av}$	$WQ_{av}$
2	1 B1	30	50	2	4	112	90	4	13	0.02	0.04
	1 B2	10	20	1	3	17	55	2.2	11	0.04	0.04
	1 both	19	25	12	21	18	27	13	100	4	14
	2	15	30	9	25	12	31	6	25	1.4	22
	3	71	84	10	22	24	30	20	30	3	22
	4	11	40	4	6	7	16	4	10	0.04	0.6
1	1'	10	15	6	14	9	17	6	15	2	12
	2'	10	24	5	20	7	23	5	20	1.6	17

## 5.4 CONCLUSIONS

The simulation results of the actual system in study give us a clear indication of the weak actual performance. The actual performance exhibits massive queue lengths and extensively high vehicular waiting times compared to normal traffic systems. Therefore, better scenarios should be proposed in order to improve the actual performance and cut off the traffic congestion problem from its root causes. Subsequent chapters are going to discuss the proposed solutions to overcome this dilemma.

## 6 SIMULATION SCENARIO1: PROPOSED SOLUTION & 3D ANIMATION USING EXTENDSIM

### 6.1 SCENARIO1 VERSUS ACTUAL MODEL

#### 6.1.1 The Actual model

In the actual traffic system being evaluated, the signal light timings were found to be fixed through all the periods of the day. This does not correspond to the variability of the vehicular demand from one period to another. As a result of the incorrect application of the pre-timed traffic system, major problems affect the system performance. This was obvious in the attained results of simulating the actual model at the end of chapter V. In addition, a major error in the phase plan of the actual model was detected. The vehicular flow turning left from control point (3) should be recognized as a separate control point.

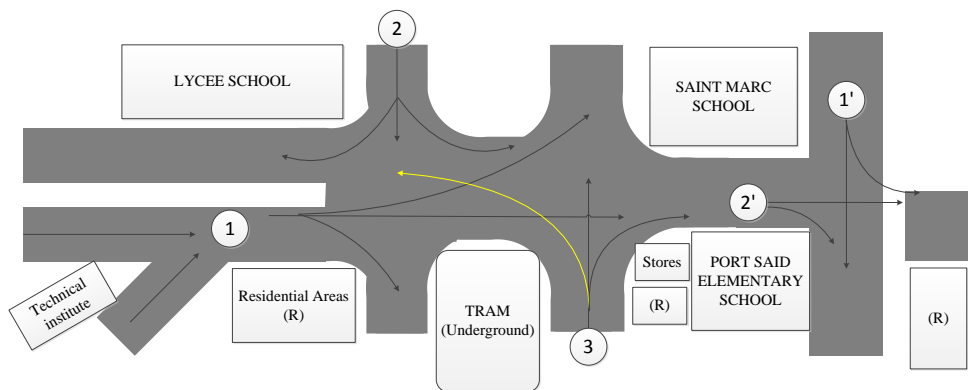

Figure 6-1: changes to actual system

What actually happens is that when vehicles desiring to turn left arrive at the intersection; they start to head onto the direction of Abo-Eir, even if it is during the green time of other control points, therefore opposing the flow of the vehicles moving from CP (2) shatby to sporting tram and the flow of the vehicles moving from CP (1) Abo-Eir to Corniche. This sort of free and uncontrolled flow causes blockages and congestion in the intersection, and prevents other control points from fully utilizing their

green times, hence leading to great percentages of lost time. The vehicular flow of this left turn commands their own traffic light signal, to allow their dissipation without interrupting the flow of other vehicles during their green time. If their own traffic light signal is installed, it will guide such vehicles waiting in queue whether they can make the left turn yet or not, considering the entire flow and phase plan of the intersection.

### 6.1.2 The proposed solution " Scenario1 "

Due to all the problems faced and observed from the actual performance of the system and the simulation of such a system, a solution is strived for. Since it is impossible to change any geometric conditions of the streets or roads, a new solution is proposed that does not require such drastic change. This is called Scenario 1. This model will still be based on a pre-timed traffic system, where the cycle length, the phase sequence and the signal interval timings are constant over a single period interval. The difference between the actual model and the proposed solution is the addition of an extra control point in intersection 2. Instead of having 3 control points in intersection 2, there are now four, as represented in the figure below.

A traffic light signal should be installed to direct the flow of the left turn of the vehicles from CP (4) Sporting tram to Abo Eir. This will prevent the problem of opposing any other flows in the intersections, due to lack of control and management that has just been described previously.

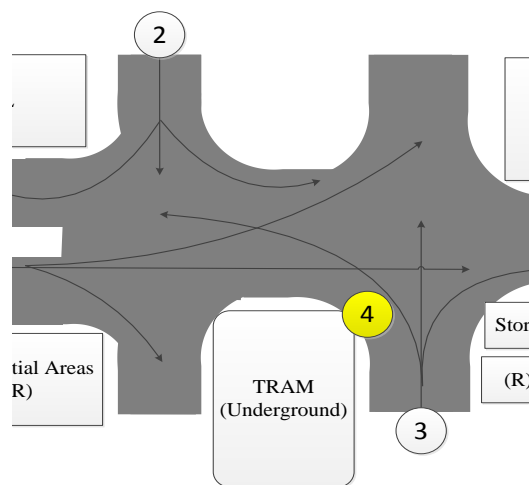
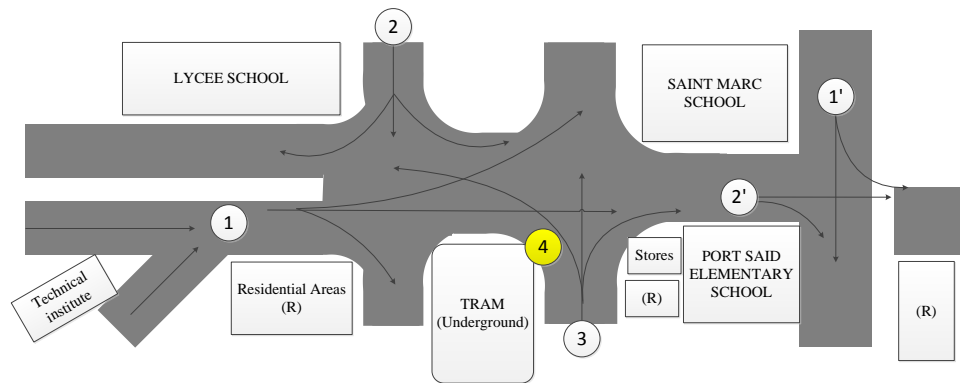

Figure 6-2: CP (4) added to scenario1 in simulation experimentation





**Figure 6-3: Intersection layout in simulation of scenario 1**

**Table 6-1: configuration of intersection (1) in simulation of scenario1**

Control Point	Description
1'	Arrivals from Saint-Marc heading to either: <ul style="list-style-type: none"> <li>• Port-said street</li> <li>• Left turn to corniche.</li> </ul>
2'	Arrivals from Tram heading to either: <ul style="list-style-type: none"> <li>• Corniche street</li> <li>• Right turn to port-said.</li> </ul>

**Table 6-2: configuration of intersection (2) in simulation of scenario1**

Control Point	Description
1	Arrivals from two branches of Abo-eir street to either: <ul style="list-style-type: none"> <li>• Intersection 1</li> <li>• Right turn to sporting tram</li> <li>• Left turn to shatby tram.</li> </ul>
2	Arrivals from Shatby to either: <ul style="list-style-type: none"> <li>• Sporting tram street</li> <li>• Right turn to abo-eir.</li> </ul>
3	Arrivals from Sporting tram to either: <ul style="list-style-type: none"> <li>• Shatby tram street</li> <li>• Right turn to intersection 1</li> </ul>
4	Left turn from sporting tram to abo-eir street.

**Table 6-3: Modified phase plan of intersection (2) in simulation of scenario1**

State	Control Point				State timing (sec)
	1	2	3	4	
A	G	R	R	R	$T_A$
B	R	G	G	R	$T_B$
C	R	R	G	G	$T_C$

## 6.2 MODEL TRANSLATION OF SCENARIO1

The proposed model "Scenario1" is built on ExtendSim8. There are familiar blocks previously identified such as the Executive, queue, activity, select item in, select item out and exit blocks.

### 6.2.1 Intersection 1

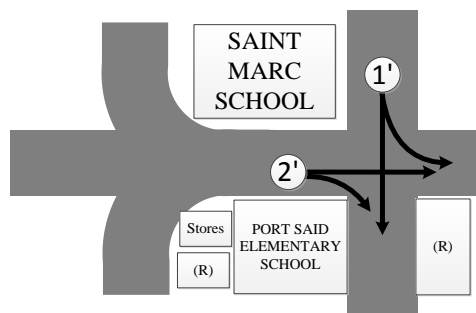

Intersection (1) is composed of two main branches (Control points):

## Port-said branch

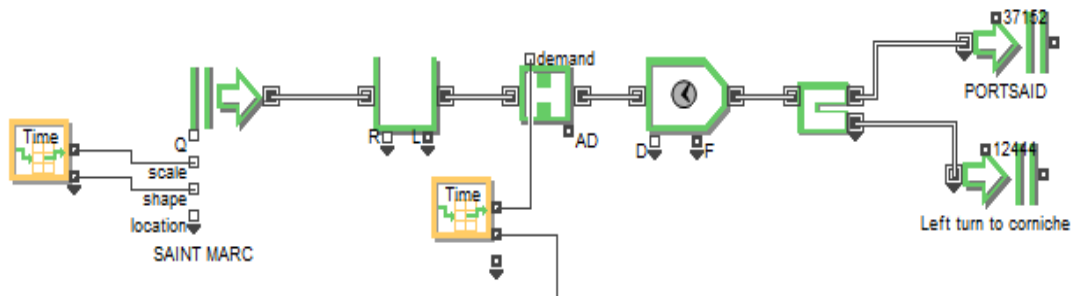

Figure 6-4: Portsaid branch of intersection (1) in simulation of scenario1

The cars enter the intersection from Saint Marc, and their arrivals are represented by the create block with its lookup table. They wait in the queue block, until their traffic light signal is green. The traffic light signal is represented by the gate block. When the vehicles are able to flow through the gate, they have a certain dissipation rate, which is indicated in the activity block following the gate. Finally, the vehicles have a choice of exiting the traffic system either by going to Portsaid or turning left to Corniche. This former flow described is represented by the select item out block, connected to exit blocks in the figure below.

## Tram to cornice branch

This branch is similar to the former branch. However, the only difference is that the arriving vehicles reach the control points through a select item in block that sums up different flows from intersection (1).

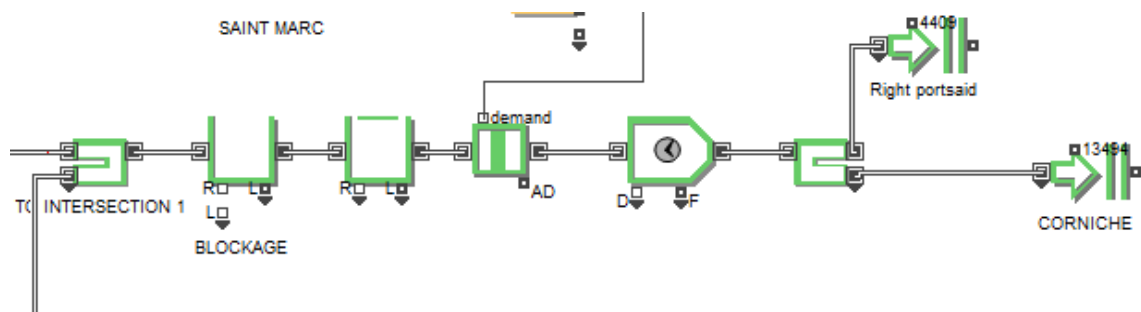

Figure 6-5: Tram to cornice branch in simulation of scenario 1

## 6.2.2 Intersection 2:

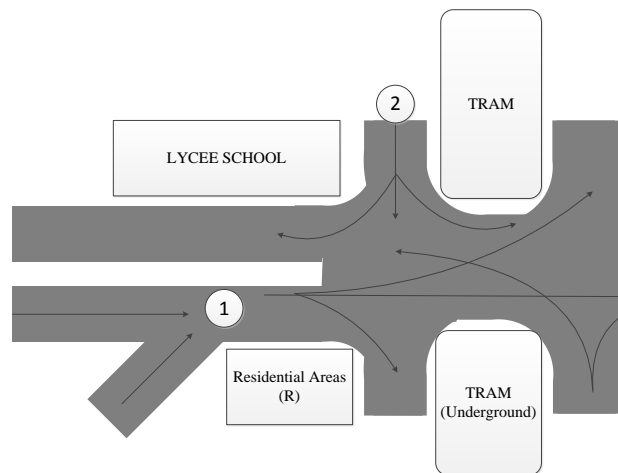

Figure 6-6: Intersection (2) in simulation of scenario 1

The model consists of the following branches:

1. Arrivals from shatby tram, ending by a "Select item out" divided the departures to either sporting tram or Right turn to abo eir.
2. Arrivals from Aboeir two-branches connected by a "Select item out" composed of three output branches :
  - To intersection 1 in the cornice direction.
  - Right turn to sporting tram
  - Left turn to shatby tram
3. Sporting tram branch, connected to a "Select item out" which has two outputs :
  - A second "Select item out" going to either straight shatby tram or right to intersection 1.
  - The left turn going to abo-Eir (the new control point added in this scenario)

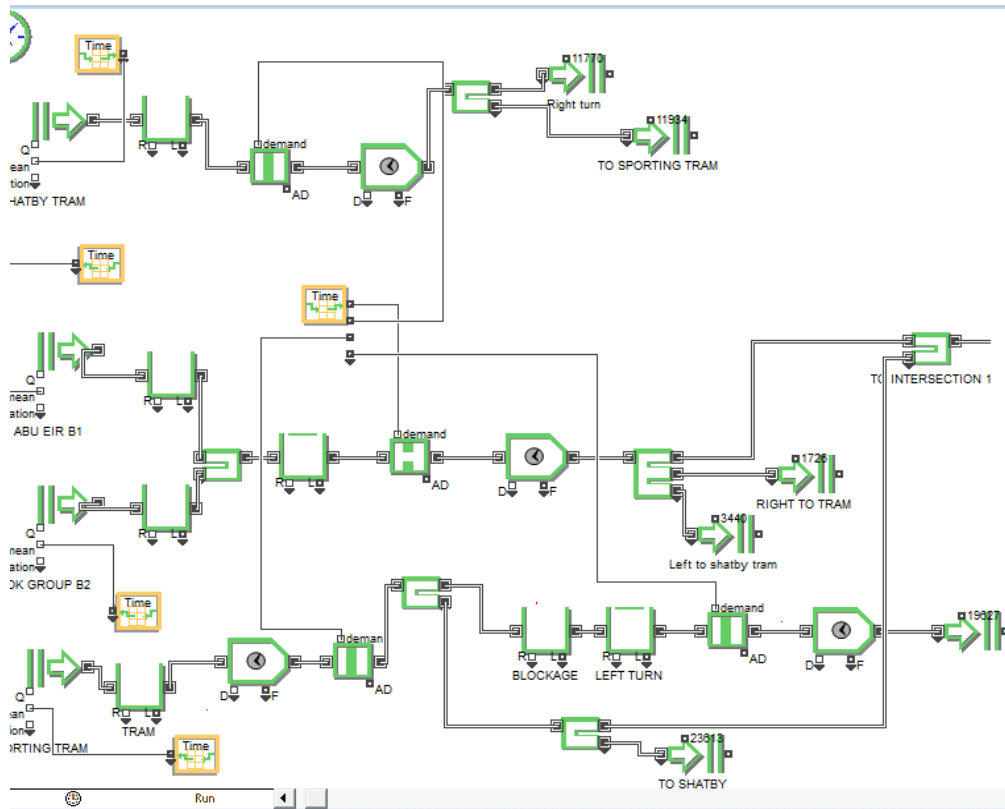

Figure 6-7: Modeling of intersection (2) in simulation of scenario 1

### 6.3 SIMULATION EXPERIMENTATION

The objective from the experimentation is to obtain a combination of signal timings of each control point that achieves the minimum of queue lengths , waiting times and cycle time in the intersection.

#### 6.3.1 Runing the model

The model is run at different timings until reaching the best solution. In every period, the timings of the proposed solution are tried at the beginning then, the results should be observed well, the highest numbers of queue lengths and waiting time should be adjusted by giving the state of these numbers more timing until reaching the best solution of the trials in almost all the control points.

## 6.4 RESULTS AND ANALYSIS

Table 6-4 summarizes all the state timings that results from the experimentation of scenario1 through all the periods of the day.

**Table 6-4: Results of simulation of scenario1**

State/Period	7-9am	9-1pm	1-5pm	5-11pm	11-7am
<b>A</b>	70	60	70	60	30
<b>B</b>	50	40	50	60	30
<b>C</b>	30	20	30	30	20
<b>A'</b>	40	50	40	40	30
<b>B'</b>	40	40	40	40	20

### 6.4.1 Scenario1 versus the actual model

Since the actual model represents the reality, the results of each period were compared to the actual model results in three different comparison standards.

- **The average queue lengths**

In each period, the average queue lengths of all the control points are calculated and compared to the averages of the actual model as shown in Table 6-5, to calculate the percentage improvement.

**Table 6-5: Comparison of scenario1 versus actual model in terms of LQav**

C.Point/Period	1		2		3		4		5	
	Average LQ		Average LQ		Average LQ		Average LQ		Average LQ	
	Actual	Scenario1	Actual	Scenario1	Actual	Scenario1	Actual	Scenario1	Actual	Scenario1
1	30	5	2	2.7	112	5	4	0.17	0.02	0.001
2	10	3	1	1.1	17	3.6	2.2	0.08	0.04	0.0008
3	19	14	12	12	18	15	13	8	4	4.5
4	15	16.8	9	13	12	17.2	6	13	1.4	3.6
5	71	32	10	14	24	35.8	20	7.4	3	1.7
6	11	5	4	4	7	5	4	5	0.04	3
7	10	6	6	10	9	6.2	6	2	2	0.8
8	10	10	5	11	7	9.6	5	11	1.6	4
Average	22	11.475	6.125	<b>8.475</b>	25.75	12.175	7.525	5.83125	1.5125	<b>2.200225</b>

- **The average waiting time**

In each period, the averages of the averages waiting time of all the control points are calculated and compared to the averages of the actual model as shown in Table 6-6, to calculate the percentage improvement.

**Table 6-6: Comparison of scenario1 vs. Actual model in terms of WQav**

C.Point/Period	1		2		3		4		5	
	Average WQ		Average WQ		Average WQ		Average WQ		Average WQ	
	Actual	Scenario1	Actual	Scenario1	Actual	Scenario1	Actual	Scenario1	Actual	Scenario1
1	50	15	4	6.8	90	15	13	1.2	0.04	0.01
2	20	13	3	5.3	55	13.5	11	0.8	0.04	0.009
3	25	24	21	20	27	24	100	30	14	25.5
4	30	40	25	33	31	41.6	25	33	22	18
5	84	32.8	22	22	30	35.6	30	15	22	7
6	40	12	6	17	16	12	10	29	0.6	28
7	15	11	14	21	17	11.5	15	10	12	5.4
8	24	12	20	14	23	11.8	20	12	17	5.5
Average	36	19.975	14.375	17.3875	36.125	20.625	28	16.375	10.96	11.17738

- **The product of average queueand waiting time**

In each period, the averages of "Averages queue\*waiting time" of all the control points are calculated and compared to the averages of the actual model as shown in Table 6-7, to calculate the percentage improvement.

**Table 6-7: Comparison of scenario1 vs. Actual model in terms of LQav\*WQav**

C.Point/Period	1		2		3		4		5	
	(Av.LQ*AvWQ)		(Av.LQ*AvWQ)		(Av.LQ*AvWQ)		(Av.LQ*AvWQ)		(Av.LQ*AvWQ)	
	Actual	Scenario1	Actual	Scenario1	Actual	Scenario1	Actual	Scenario1	Actual	Scenario1
1	1500	75	8	18.36	10080	75	52	0.204	0.0008	0.00001
2	200	39	3	5.83	935	48.6	24.2	0.064	0.0016	0.0000072
3	475	336	252	240	486	360	1300	240	56	114.75
4	450	672	225	429	372	715.52	150	429	30.8	64.8
5	5964	1049.6	220	308	720	1274.48	600	111	66	11.9
6	440	60	24	68	112	60	40	145	0.024	84
7	150	66	84	210	153	71.3	90	20	24	4.32
8	240	120	100	154	161	113.28	100	132	27.2	22
Average	1177.375	302.2	114.5	179.1488	1627.38	339.7725	294.525	134.6585	25.5033	37.72125215

### 6.4.2 Percentage improvement calculation

$$\text{Percentage reduction in LQav} = \frac{LQ_{av \text{ actual}} - LQ_{av \text{ scenario1}}}{LQ_{av \text{ actual}}}$$

$$\text{Percentage reduction in WQav} = \frac{WQ_{av \text{ actual}} - WQ_{av \text{ scenario1}}}{WQ_{av \text{ actual}}}$$

$$\text{Percentage reduction in } (LQ_{av} * WQ_{av}) = \frac{LQ_{av} * WQ_{av} \text{ actual} - LQ_{av} * WQ_{av} \text{ scenario1}}{LQ_{av} * WQ_{av} \text{ actual}}$$

**Table 6-8: Percentage improvement values in different periods of the day for scenario1**

Periods	Percentage improvement of LQ Average	Percentage improvement of WQ Average	Percentage improvement of LQ*WQ Average
1	47.8%	44.5%	74%
2	-38.3%	-21%	-56.4%
3	52.7%	43%	79%
4	22.5%	41.5%	54.2%
5	-45%	-2%	-48%

The percentage improvements displayed in Table 6-8 show great decrease in, the average queue lengths and the average waiting times and the "average queue\*average waiting time" among all the periods except the second and fifth periods of the scenario1 in compared to the actual system. The Charts 6-8, 6-9 and 6-10 represent comparisons between the proposed solution scenario1 and the actual system.

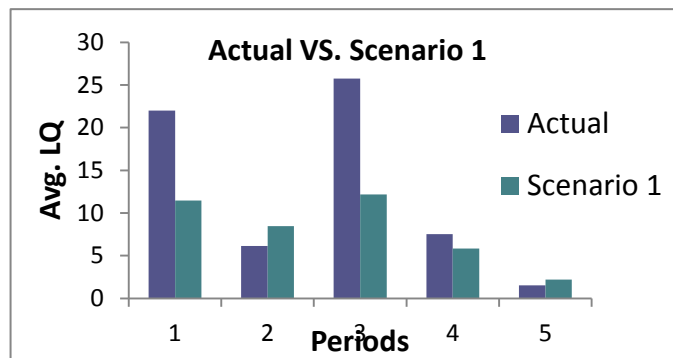

**Figure 6-8: Actual vs. Scenario 1 in terms of LQav**

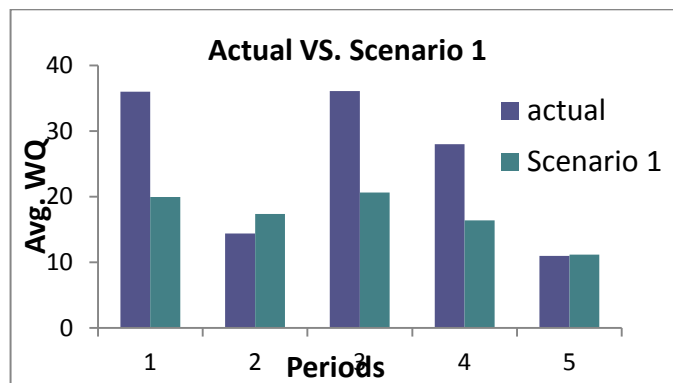

**Figure 6-9: Actual vs. Scenario1 in terms of WQav**



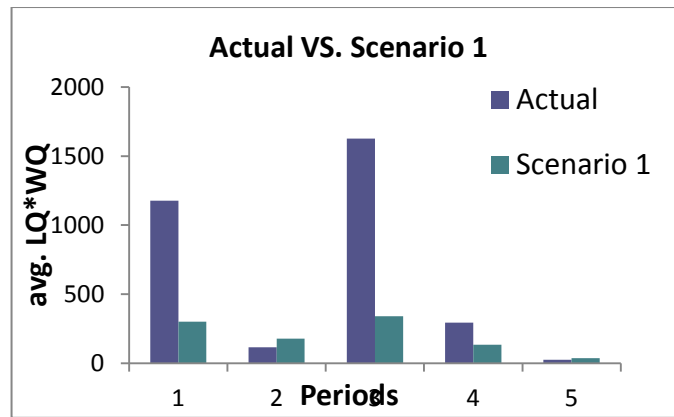

Figure 6-10: Actual vs. Scenario1 in terms of (LQav \* WQav)

### 6.4.3 Overall percentage improvement

Hence, the overall percentage improvement for scenario1 through all periods can be easily computed.

The general average queue length has decreased by 4 %, while the general average waiting time has reduced by **29.6 %**.

## 6.5 3D ANIMATION IN SIMULATION

Despite the amount of data that such studies produce, a 3D representation of the system creates a more complete understanding of system behavior because the ideal solution should enable the visual communication of the static and dynamic details of simulation models in addition to establishing the credibility of the analysis in its entirety.

### 6.5.1 Introduction to Extendsim8 animation

The ExtendSim Suite package includes a next generation 3D animation capability that provides a three-dimensional representation of the world of the model. The 3D environment is independent of, but integrated with, the logical model – 3D animation can be added after the model has been validated. The objects modelled in the 3D world maintain information about their spatial locations in three dimensions as well as their other physical and behavioural properties

## 6.5.2 3D animation of intersection (1)

It was decided to apply the 3D animation on the intersection1 of the scenario1.

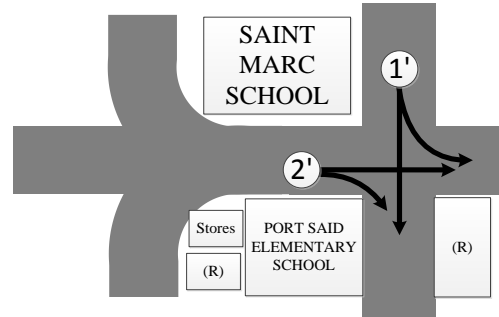

Figure 6-11 is the created 2D model in order to produce the 3D animation

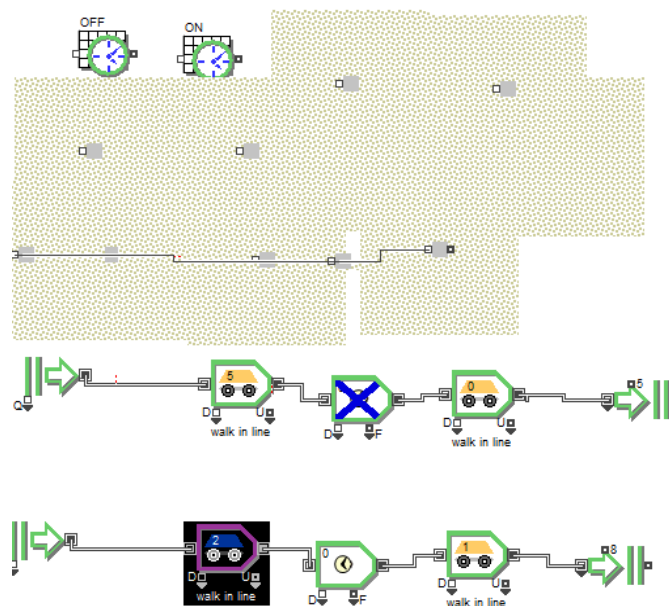

Figure 6-11: 2D model used to generate 3D animation of intersection (1)

Figure 6-12 is a snapshot of the generated 3D animation:



Figure 6-12: 3D animation of intersection (1)

## 6.6 CONCLUSION AND RECOMMENDATIONS

The proposed simulation model has made improvements in the traffic system among the day compared to the actual system, the results of the experimentations showed a reduction in the overall queue length and vehicular waiting time.

Scenario1 which is based on dividing the day into periods each having a specific fixed timing proved that it is more successful than the actual traffic system because the solution has solved the variability in the demand of the cars through all the different periods.

Concerning the intersection been studied, It is strongly recommended to use the adjusted phase plan, previously discussed, and to apply the proposed solution for the different periods of the day to enhance the performance of this traffic system. A reliable control strategy is also needed to promote the awareness of the people to the new traffic signals in alexandria.

Table 6-9 summarizes all the attained signal timings through simulation experimentation for the road network under study.

**Table 6-9: Signal timings for scenario (1)**

			Period				
Int.	C.P.	Timing	7-9am	9-1pm	1-5pm	5-11pm	11-7am
2	1	$TG_1, TR_1$	70,80	60,60	70,80	60,90	30,50
	2	$TG_2, TR_2$	50,100	40,80	50,100	60,90	30,50
	3	$TG_3, TR_3$	80,70	60,60	80,70	90,60	50,30
	4	$TG_4, TR_4$	30,120	20,100	30,120	30,120	20,60
1	1'	$TG_{1'}, TR_{1'}$	40,40	50,40	40,40	40,40	30,20
	2'	$TG_{2'}, TR_{2'}$	40,40	40,50	40,40	40,40	20,30

## **7 SIMULATION OF AN ADAPTIVE TRAFFIC CONTROL SYSTEM**

### **7.1 INTRODUCTION**

Actuated signal control, also called adaptive or smart system, is a newly introduced control strategy that is used nowadays in most developed countries. This strategy greatly differs than the pre-timed control strategy in many aspects.

- **Pre-timed strategy:** The traffic signal provides a fixed amount of green time to each approach during a cycle. This green duration is constant over a single period interval; however the signal timings and cycle lengths may vary from an interval to another in order to reflect the changes in traffic volumes and patterns.
- **Full actuated control (adaptive):** The traffic signal provides green time to each intersection approach based on instantaneous arrivals for a cycle. Generally, as arrivals change from cycle to cycle, the length of green time provided to each approach also changes.

Unlike the pre-timed strategy, Adaptive traffic control systems (ATCSs) use real-time traffic data to optimize signal timing parameters in order to minimize traffic delays and stops. One significant difference between ATCSs and traditional pre-timed strategies is that ATCSs can proactively respond to real-time traffic flow changes, therefore are expected to be more efficient for signal system operations. Adaptive traffic control systems adapt their timings based on the current demand patten. This demand patten can be obtained through the presence of traffic sensing devices.

### **7.2 HISTORY OF ADAPTIVE TRAFFIC SYSTEMS**

Adaptive Traffic Control System (ATCSs) is a relatively new method compared to traditional traffic control systems. It was first introduced by Miller in 1963, when he proposed a traffic signal control strategy that was based on an online traffic model. However, the first real-world application did not occur until the early 1970's when

Sydney Coordinated Adaptive Traffic System (SCATS) was first implemented in Australia. A few years later the Split Cycle Offset Optimization Technique (SCOOT) was developed and implemented by the UK Transport Research Laboratory. After wide applications of SCOOT and SCATS in different countries, the Federal Highway Administration (FHWA) sponsored several ATCSs developments, including Online Public Access catalogue (OPAC), RHODES and Adaptive Control Software Lite (ACS Lite).

Nevertheless, the number of ATCS deployments in the U.S. is still limited. Currently, there are only about 30 system deployments in the U.S., and more than 95% of the coordinated traffic signals are still being operated under the pre-timed strategy.

### 7.3 ADAPTIVE CONTROL SYSTEMS: THEORY OF OPERATION

Adaptive traffic signal control is the process by which the timing of a traffic signal is continuously adjusted based on the changing arrival patterns of vehicles at an intersection. This process is done by installing sensors at an intersection, when a vehicle is detected a signal is sent to a controller which processes the vehicle arrival times, and then the timings are sent to the light signal.

Figure 8-1 shows the theory of operation of an adaptive traffic control system.

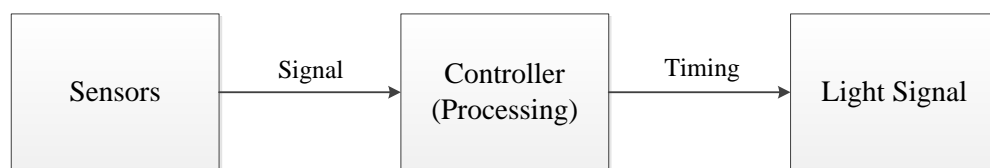

Figure 8-1: Theory of operation of adaptive traffic control systems

### 7.4 MODEL TRANSLATION

Using Extendsim8, a powerful simulation package, a simulation model is developed to replicate the performance of an adaptive traffic control system. The adaptive traffic control strategy is applied on intersection “1” only due to the general complexity of the adaptive system compared to the pre-timed strategy.

Therefore crucial changes had to be made to the existing simulation model, by adding extra blocks. These changes are discussed below. For more information about the original model, refer back to chapter 5.

### Max & Min block

This block determines the maximum and minimum values amongst the input values. The input connectors are connected to the queues' blocks. The max & min block determines the maximum or minimum value, in this case the maximum value. Afterward the block outputs the values on output connector (1) and the respective connector number on output connector (2).

### Equation block

This block uses the set of input variables and a defined equation to update the set of output variables. The block takes its input from the output of the max & min block, in addition to other variables that support the equation needs. Subsequently the output variables are connected to the lookup table block, which will be discussed later. The equation block is demonstrated in Figure 7-2.

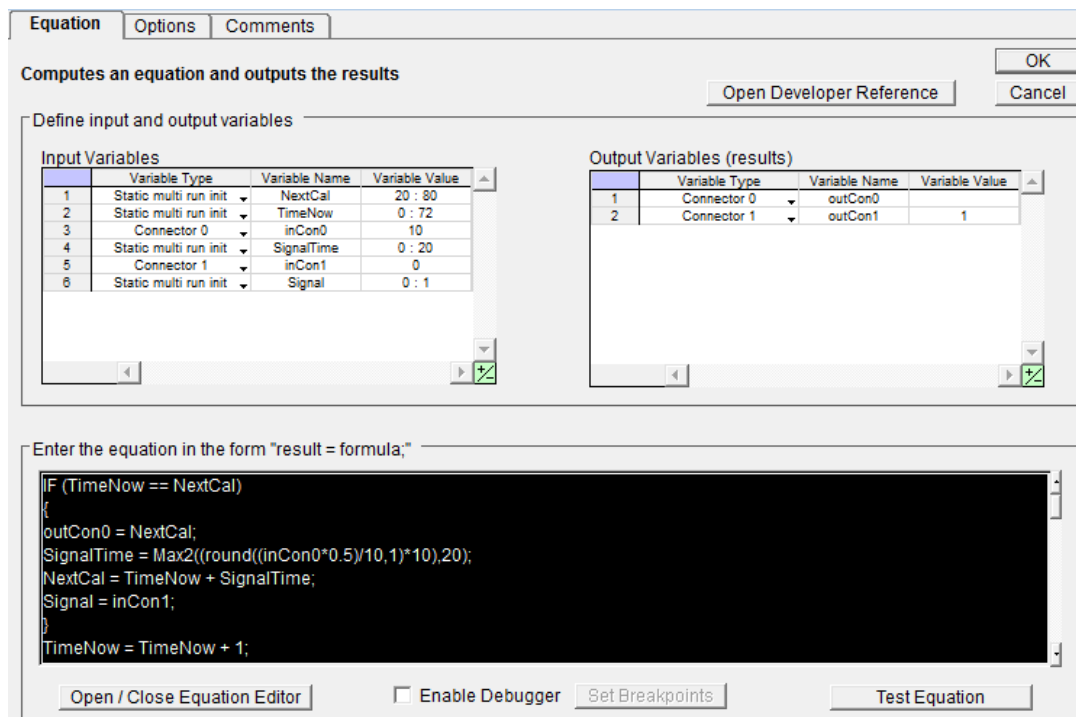

Figure 7-2: Equation block used to calculate the adapted signal timing in ATCs modeling

In this case the equation block is the most important block, since it acts as the controller that produces the signal timing. The block contains a developed equation that renders the value of the signal timing. The equation is illustrated in Figure 7-3.

```

Enter the equation in the form "result = formula;"
IF (TimeNow == NextCal)
{
outCon0 = NextCal;
SignalTime = Max2((round((inCon0*0.5)/10,1)*10),20);
NextCal = TimeNow + SignalTime;
Signal = inCon1;
}
TimeNow = TimeNow + 1;

```

**Figure 7-3: Equation used to calculate adapted signal timing in ATCs modeling**

As mentioned previously, variables are added in order to maintain the equation needs, as shown below. The third and fifth variables shown are the output values from the max & min block. The first variable states that multiple replications will be made with a starting condition of 20 seconds, which is constant as stated in the fourth variable. The second variable shows the current time in seconds while the model is running, and the last variable states the signal time.

Define input and output variables

Input Variables

	Variable Type	Variable Name	Variable Value
1	Static multi run init	NextCal	20 : 80
2	Static multi run init	TimeNow	0 : 72
3	Connector 0	inCon0	10
4	Static multi run init	SignalTime	0 : 20
5	Connector 1	inCon1	0
6	Static multi run init	Signal	0 : 1

**Figure 7-4: input variables to the equation block in ATCs simulation modeling**

Lookup table 

Lookup tables assign output values for correspondent input values. In this case, the table takes the input from the equation block, looks up the correspondent value. This value is assigned to the demand connector of one of the two gates that represent the traffic signals, as shown in Figure 7-5.

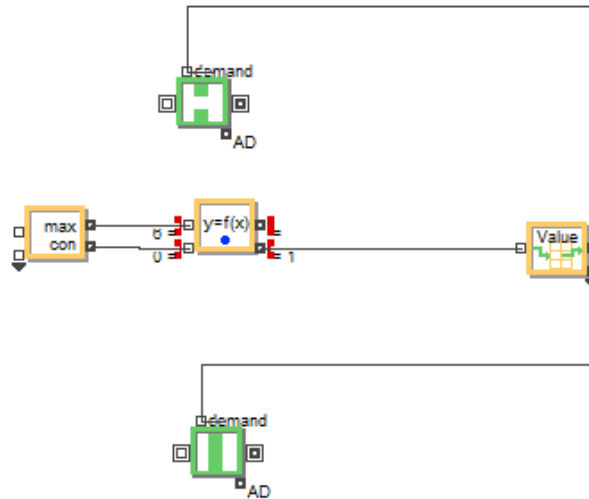

**Figure 7-5: signalization process in ATC's simulation modeling**

Figure 7-6 represents the adaptive model of intersection "1". The two queue blocks are connected to the max & min block to determine the maximum queue. The max & min block is respectively connected to the equation block calculating the signal timing, which in turn leads to the lookup table. This table determines which gate to be opened based on the input value taken from the equation block. The process keeps repeating itself until the run time is over.

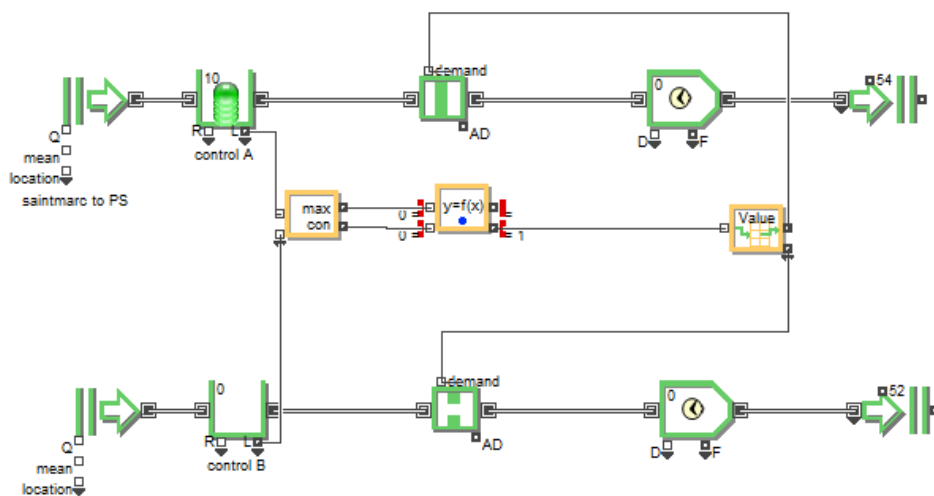
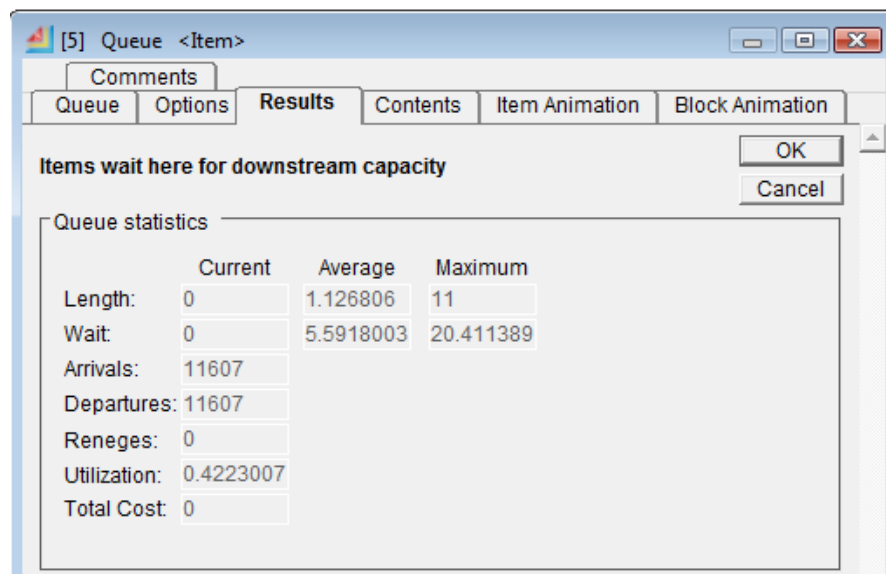

**Figure 7-6: ATC simulation modeling of intersection (1)**



## 7.5 SIMULATION EXPERIMENTATION

Now that the model is developed, and all the constraints and variables are set, calibration for each period is made in order to ensure that the model is running properly. The model runs for a day and is distributed on five periods, each period has a model. Calibration is achieved by running each model according to its period time, and checking the queue block for the maximum queue length and the maximum waiting time, as shown below. If the values are reasonable then the model is working effectively, if not then the model needs to be modified before starting the experimentation.



**Figure 7-7: verification of system metrics in ATCs modeling**

As soon as the calibration proves the effectiveness of the model, the experimentation phase starts. Each model of the five periods is run ten times, in order to ensure the accuracy and reliability of the results. The average queue lengths and the average waiting times of each of the five periods, and the two control points are documented in tables on excel sheets as in Figure 7-8.

	A	B	C	D	E	F	G	H	I	J	K
1	Run 1	period 1		period 2		period 3		period 4		period 5	
2	control points	Queue AV	waiting AV	Queue AV	waiting AV	Queue AV	waiting AV	Queue AV	waiting AV	Queue AV	waiting AV
3	A	2.8	8.13	1.46	5.79	3.99	10.02	1.12	5.59	0.49	4.95
4	B	3.31	6.82	2.12	6.06	5.15	7.76	2.5	6.33	0.87	5.23
5											
6											
7	Run 2	period 1		period 2		period 3		period 4		period 5	
8	control points	Queue AV	waiting AV	Queue AV	waiting AV	Queue AV	waiting AV	Queue AV	waiting AV	Queue AV	waiting AV
9	A	2.7	8.13	1.47	5.71	4.08	10.1	1.13	5.64	0.5	4.99
10	B	3.38	6.74	2.18	6.18	5.15	7.79	2.59	6.44	0.88	5.3
11											
12											
13	Run 3	period 1		period 2		period 3		period 4		period 5	
14	control points	Queue AV	waiting AV	Queue AV	waiting AV	Queue AV	waiting AV	Queue AV	waiting AV	Queue AV	waiting AV
15	A	2.67	7.93	1.46	5.8	4.17	10.34	1.1	5.53	0.49	4.97
16	B	3.58	7.01	2.17	6.13	5.27	7.87	2.53	6.35	0.86	5.16
17											
18											
19	Run 4	period 1		period 2		period 3		period 4		period 5	
20	control points	Queue AV	waiting AV	Queue AV	waiting AV	Queue AV	waiting AV	Queue AV	waiting AV	Queue AV	waiting AV
21	A	2.47	7.61	1.45	5.84	4.07	10.06	1.11	5.64	0.48	4.9
22	B	3.34	6.86	2.22	6.2	5.22	7.81	2.55	6.35	0.88	5.27
23											
24											
25	Run 5	period 1		period 2		period 3		period 4		period 5	
26	control points	Queue AV	waiting AV	Queue AV	waiting AV	Queue AV	waiting AV	Queue AV	waiting AV	Queue AV	waiting AV
27	A	2.56	7.83	1.41	5.66	3.94	9.91	1.11	5.55	0.49	5.02

Figure 7-8: Results shown on excel sheets of ATCs modeling

Table 7-9 is a summary of the averages of the total runs for each of the five different periods, which was calculated to measure the system's performance and to ensure that there are no errors or exceptions among the results.

AVERAGE	period 1		period 2		period 3		period 4		period 5	
control points	Queue AV	waiting AV	Queue AV	waiting AV	Queue AV	waiting AV	Queue AV	waiting AV	Queue AV	waiting AV
A	2.645	7.972	1.431	5.735	4.048	10.109	1.113	5.569	0.491	4.982
B	3.425	6.829	2.191	6.06	5.182	7.782	2.542	6.358	0.868	5.225

Figure 7-9: Results (2) shown on excel sheets of ATCs modeling

## 7.6 The Adaptive Model Versus the Actual Model

As mentioned previously, the averages of the total runs of each period are calculated for both, the average queue lengths and the average waiting times. Afterwards, the attained results are compared to those of the actual model. This is carried out in order to calculate the percentage of improvement in the system performance. The calculations are measured using the following equations:

- % reduction in  $LQ_{avg} = \frac{LQ_{avg1} - LQ_{avg2}}{LQ_{avg1}}$
- % reduction in  $WQ_{avg} = \frac{WQ_{avg1} - WQ_{avg2}}{WQ_{avg1}}$
- % reduction in  $(WQ_{avg} * LQ_{avg}) = \frac{TS_{avg1} - TS_{avg2}}{TS_{avg1}}$

Table 7-1 shown below illustrates the improvement percentages throughout the periods of the day:

**Table 7-1: Values of percentage improvement of ATCs through all periods of the day**

periods	% improvement of avg. LQ	% improvement of avg. WQ	% improvement of (avg. WQ * avg. LQ)
1	70	62	88.6
2	67.3	65.3	88.4
3	42.5	55.5	74.1
4	67.3	65.7	88.2
5	61.1	64.8	86.3

As shown in the previous table, the percentages demonstrate great improvement in both, the average queue lengths and the average waiting times among all the different periods in the adaptive system compared to the actual system. These results prove the validity of the model, that it runs efficiently and that the adaptive system is much more effective than the actual model. Some graphs are illustrated for more demonstration.

All the graphs below represent comparisons between the adaptive and the actual systems, for each of the five different periods of the day.

Chart 7-10 compares the general average queue length between the adaptive system and the actual system.

The improvements of the adaptive system are observable in the graph below, not only in the peak periods but in all of the periods as well.

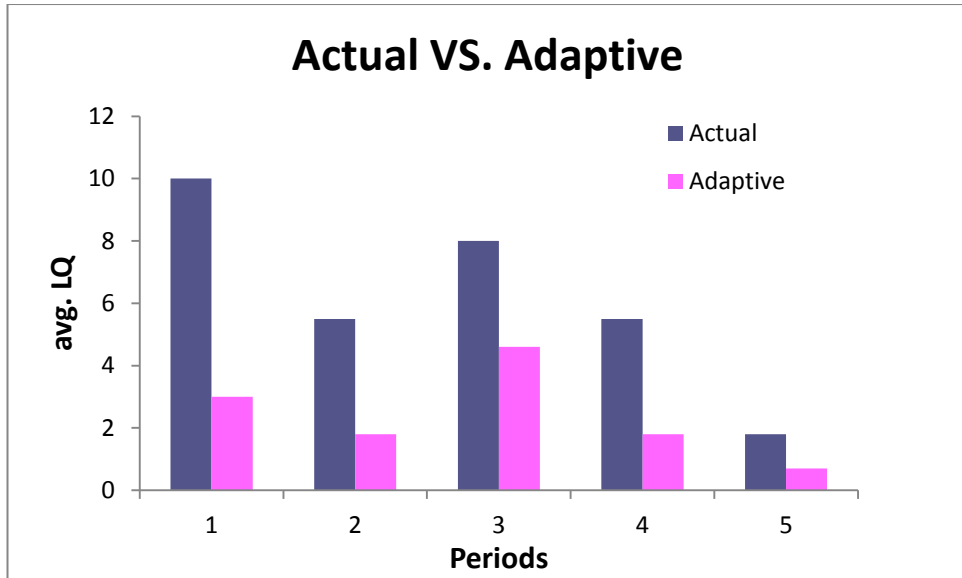

**Figure 7-10: Actual vs. adaptive model in terms of LQav**

Chart 7-11 compares the general average waiting time between the adaptive system and the actual system for each of the five periods of the day, and for both control points. This graph also showed huge improvements of the adaptive system compared to the actual system performance.

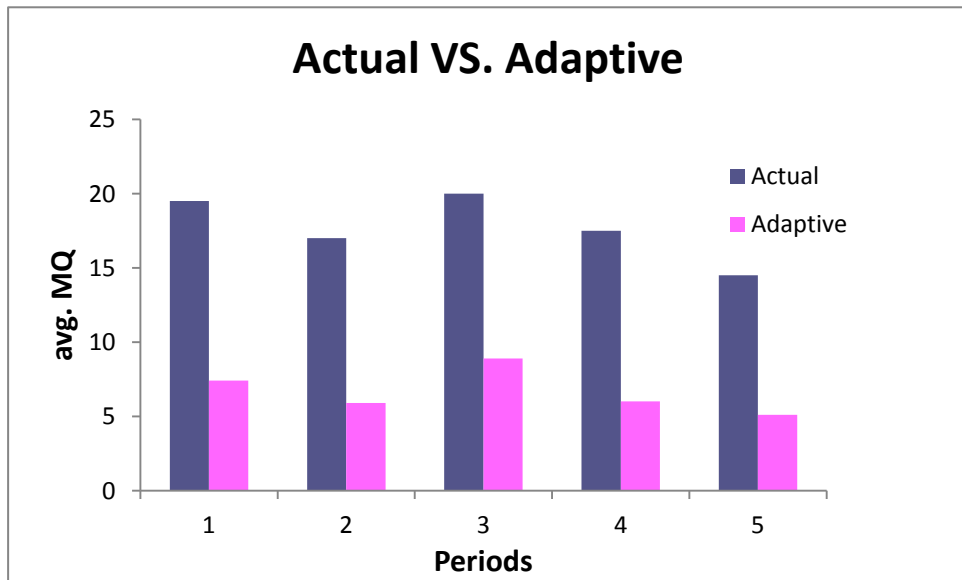

**Figure 7-11: actual vs. adaptive model in terms of WQav**

The third and final Figure 7-12 compares the adaptive system and the actual system in terms of the general average queue length, multiplied by the general average waiting time, at both control points for all periods of the day.

The improvement of this graph shows the greatest reduction in percentages among the five periods compared to the two graphs discussed previously.

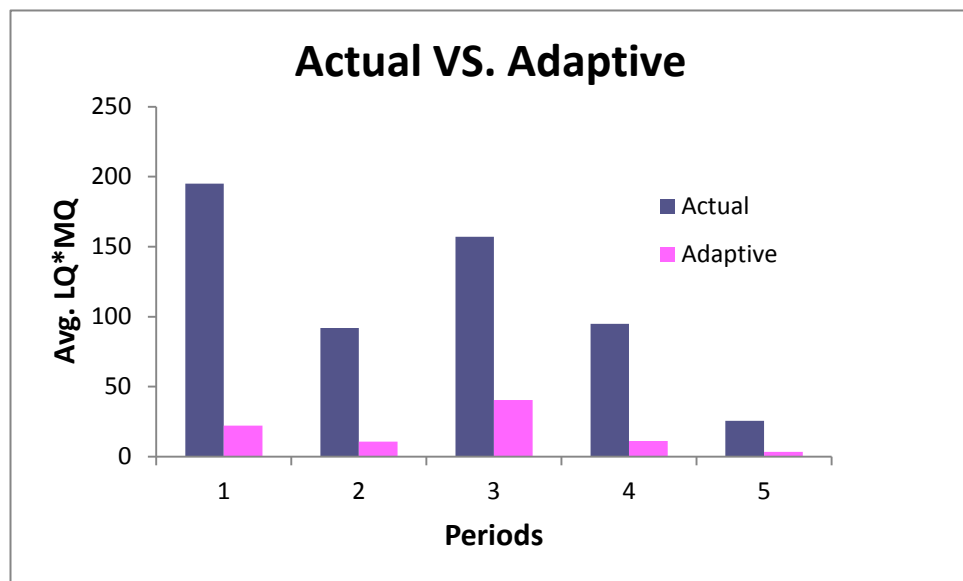

**Figure 7-12: Actual vs. adaptive model in terms of (LQav \* WQav)**

Hence, the overall percentage improvement for the adaptive system through all periods can be easily computed.

The general average queue length has decreased by **74 %**, while the general average waiting time has reduced by **69.2 %**.

## 7.7 Conclusions and Recommendations

The model representing the adaptive system is developed for the purpose of improving the traffic system's performance. It aims to decrease the queue lengths and the waiting times that the vehicles spend in the traffic environment. Multiple runs are performed for five different periods over a day, and the results are quite reasonable and efficient. All ten runs produced very similar results for each period, which proves the reliability and accuracy of the model, as well as the effectiveness of the adaptive system.

The comparisons made between the actual system and the adaptive system, showed huge reductions in the queue lengths and the average waiting times of the adaptive system compared to the actual, among all the periods of the day.

The adaptive system was expected to have better performance than the actual system, because it instantaneously adapts the timings based on the demand pattern. On the other hand, the actual system adopts a chaotic strategy and gives fixed light signals through all periods of the day. Therefore, the adaptive system has been proved to be better and more efficient than the actual system.

## **Recommendations**

Due to the experimentation and conclusions analyzed and discussed in this chapter, the implementation adaptive traffic control system is highly recommended. However, there are some drawbacks and requirements that should be considered in order to develop the adaptive system in Alexandria streets. Examples of these drawbacks and requirements are discussed briefly below.

- **Awareness:** there is little awareness of the high technologies involved in the adaptive system strategy. Therefore the system should be introduced first to the traffic department before any decisions are made.
- **Feasibility:** the adaptive system requires sensors as mentioned previously. Most of these sensors require professional installation, and usually affects the infrastructure of the roads, which is not currently possible in Egypt due to the geometrical designs of its roads.
- **Safety:** some of the sensors used in the adaptive system are installed on pavements or within easy reach to people; therefore it must be protected so it wouldn't be vandalized or stolen. In addition, the weather of the surrounding environment is a critical measure since some sensing devices do not perform effectively under bad weather conditions.
- **Adequate maintenance:** Sensors used in the adaptive system require professional handling. Therefore, proper maintenance is needed regularly in order to maintain the safety and feasibility of the sensors and the traffic system.
- **Expenses:** the costs of purchasing and installing the hardware devices can be very high. Specially the controller unit which is the most important device in the adaptive system.

## **8 EXTENDSIM OPTIMIZATION USING SIMULATION**

### **8.1 INTRODUCTION**

Many analysts and researchers are moving towards the path of computer simulation, as a tool to explore the underlying system's behaviour. However, the replication of a system is never enough for resolving a problem. Accordingly, it is often of significant importance to perform the optimization process on a simulation model, as a means for determining the best set of input variable values that will improve a system's performance.

This is principally the aim of the following chapter, to provide the best/optimum set of traffic signal timings for a pre-timed traffic system, in order to counteract the problem of traffic congestion in hand.

In the previous chapters contained within the report, the actual traffic system under study has been successfully modelled both analytically and by using computer simulation on the ExtendSim8 software package. Furthermore, solutions have been proposed through the optimization of the analytical model using the Genetic Algorithm method. This chapter focuses on achieving the best solutions possible through optimization using simulation. Both the actual model of the system and the proposed solution presented in chapters V and VI are to be optimized.

#### **Why use simulation optimization?**

The optimization of the traffic light signals for the simulated models is performed using a powerful tool, the ExtendSim8 optimizer. Since it would be inaccurate and very timely to manually experiment with the model, in order to optimize the traffic light signals to ensure the best performance, it is simpler to refer to a program that would do so, such as the ExtendSim8 optimizer.

This chapter is divided up into many different sections, as enumerated briefly below:

- **Introduction to optimization & Simulation optimization**

This section gives a quick and brief review on the general optimization process and the importance of optimization using simulation.

- **The ExtendSim8 optimizer**

The following section covers the theory of operation of the optimizer within the ExtendSim software, as well as a brief on its benefits and limitations.

- **Model formulation**

This is the formulation of the general model that represents the traffic control system, listing the objective functions, decision variables, and constraints.

- **Model translation**

This section describes any additional or adjusted blocks in the model.

- **Optimization of the actual and proposed simulation models**

This segment covers how the optimization process takes place. The actual and the proposed model (scenario 1) are optimized using the ExtendSim8 optimizer.

- **Optimizer results for actual model**

- **Optimizer results for scenario1**

- **Conclusions and Recommendations**

## **8.2 OPTIMIZATION & SIMULATION OPTIMIZATION**

Before continuing on to the solution approach using simulation Optimization on ExtendSim8, one must refresh their memories with a general outline on optimization and simulation optimization.



## **What is optimization?**

The optimization process can simply be defined as the process by which the best or optimum results are achieved under given circumstances. Any optimization technique should consist of three sets of elements that are obligatory; an objective function that is to be maximized or minimized, a collection of variables and quantities that can be manipulated in order to achieve the specified objective function, and finally a set of constraints that restrict the values of the decision variables. The optimization process tries to find different solutions corresponding to the dilemma, until the best set of variables achieved.

Various optimization techniques have been developed. The factors that determine the optimum solution will of course vary from one situation to another. Many analysts confer to optimization techniques to optimize costs, time required or even raw materials used. Optimizations are also performed for obtaining both the local and global optima, which are discussed in greater detail in the literature review chapter.

### **8.2.1 Simulation optimization**

As specialists are increasingly using simulation as an analysis tool of performance nowadays, a simple imitation and evaluation of the model is not enough as a proposed solution to a given problem. Proceeding the simulation modelling, simulation optimization should be carried out, to find the best input variable values, from amongst all possibilities, in order to satisfy the specified objective function.

### **8.2.2 Simulation optimization using ExtendSim**

It is always an option to optimize the model of the problematic traffic system manually, by verifying the problem areas in the system based on outputs such as highest queue lengths and waiting time, and allowing those control points a larger green timing. However, this may not be the smartest of all options, because despite solving the problem in one problematic control point in the intersection, such a solution may reflect onto another section of the given intersection, perhaps creating complications or bottlenecks that didn't initially exist in the real system. In addition, such trial and error would be cumbersome, time consuming, and maybe even impossible. Therefore is

necessary to search for another method to optimize the traffic light signals of the intersection.

Simulation optimization has been used by many researchers to determine the optimum traffic light timings. The ExtendSim8 software package is thought to be appropriate in this case. It has previously been used to simulate both the actual and proposed traffic system. It includes a powerful optimizer, which is utilized to optimize the model, and find the optimum traffic light signals.

### **8.2.3 The ExtendSim Optimizer**

ExtendSim8 software facilitates an evolutionary optimizer, which employs powerful algorithms to determine the best model configuration. The incorporated optimizer determines the ideal values for the parameters in a model through running the model many times, using different values for the selected parameters, and it searches the solution spaces until an acceptable solution is obtained. The ExtendSim tries to reach the specified objective function, by saving the user from going through this draining process manually.

### **8.2.4 Theory of the ExtendSim8 optimizer**

For optimization using ExtendSim8, first the problem is stated as an objective function or cost equation, and ExtendSim tries to minimize/maximize it. Very similar to most optimization algorithms, where random sets of solutions are tried and evaluated, the ExtendSim optimizer solves the models using an initial population of the possible solutions. Each one of those solutions is then further explored, using different values for some of decision variables. The best solution sets of those parameters are then used to derive a new generation of slightly different but possibly better solutions. This is an on-going process, until enough generations are reached, and the optimizer determines that there are probably no superior solutions in sight.

However, the ExtendSim optimizer has also a few minor shortcomings. The problem of the local optima that has been covered in the literature review may occur. The optimization algorithms are unable to specify exactly when the best solution has been found. As long as the objective function is showing a decrease/increase in its value, the optimization process continues, but when the process terminates, there is no assurance

that the minimum/maximum value returned is in fact the optimum. No optimization algorithm is guaranteed to produce the best answer in a limited time and that is why running the optimization procedure several times is of great importance.

Furthermore, the optimization model needs to run continually, and this may take extremely long times particularly with larger models, such as the traffic model under study.

### **8.3 MODEL FORMULATION**

Before starting with the steps of optimization, the problem in hand must be clarified, and all the decision variables, objective functions and constraints must be stated in order to fully understand the specified traffic system.

The entire model formulation concerning the whole traffic study is described in great detail in chapter IV for both the actual and proposed solution. This chapter only focuses on the decision variables, the objective functions and system parameters regarded by the optimization process for two simulation models, the actual and proposed solution. For further reading on the proposed model and phase plan refer to chapter VI.

#### **8.3.1 Problem Decision Variables**

The decision variables are vital as they are a set of independent variables that need to be experimented with to solve the problem. Changing the values of a system's decision variables will affect the behaviour of the system, and the effects of those changes are evaluated. The best value for the set of those decision variables can be found through optimization, in order to try to overcome the causes of the traffic system problem.

The general model under construction considers any road network with (L) consecutive intersections, (N) feasible states and (M) control points, where:

*The number of consecutive intersections:  $k = \{1, 2, 3, \dots, l\}$*

*The number of states:  $i = \{A, B, \dots, N\}$*

*The number of control points:  $j = \{1, 2, 3, \dots, M\}$*

The general phase plan that can be applied on any given intersection is described in detail in chapter IV, and reference can be made to it.

The decision variables for the general case are stated as follows :

$T_{ik}$  : State timing in intersection (j), where  $i = \{A, B, C, \dots, N\}$ ,  $k = \{1, 2, 3, \dots, l\}$

The cycle time of the intersection is the sum of the state timings of the intersection:

$CT_k$  : Cycle time of the intersection, where  $CT_k = \sum_{i=A}^N T_i$

For the more specific problem of the two intersections under study for the proposed phase plan as an example, there will be two state timings in intersection (1), three state timings in intersection (2) and one cycle time for each intersection:

$T_{A1}$  : State timing of state (A) in intersection (1)

$T_{B1}$  : State timing of state (B) in intersection (1)

$T_{A2}$  : State timing of state (A) in intersection (2)

$T_{B2}$  : State timing of state (B) in intersection (2)

$T_{C2}$  : State timing of state (C) in intersection (2)

$CT_1$  : Cycle time of intersection (1), where  $CT_1 = \sum_{i=A}^B T_{i1} = T_{A1} + T_{B1}$

$CT_2$  : Cycle time of intersection (2), where  $CT_2 = \sum_{i=A}^B T_{i2} = T_{A2} + T_{B2} + T_{C2}$

An important fact must be pointed out regarding the state timings. The state timings just described are not the respective green and red timings that are to be displayed on the traffic light signals. Those are called the traffic signal timings where:

$TG_{jk}$  : the green timing interval for a control point (j) in an intersection (k)

$TR_{jk}$  : the red timing interval for a control point (j) in an intersection (k)

The green and red timings for each control point are not decision variables for the optimization process. Instead, they are can be related to the state timings through a series of calculations. The exact derivations of those calculations are covered in chapter

IV. The equations below provide an example of the equations that tie together the state timings and the traffic signal timings for intersection two in the proposed solution.

$$TG_1 = T_{A2}, \quad TR_1 = T_{B2} + T_{C2}$$

$$TG_2 = T_{B2}, \quad TR_2 = T_{A2} + T_{C2}$$

$$TG_3 = T_{B2} + T_{C2}, \quad TR_3 = T_{A2}$$

$$TG_4 = T_{C2}, \quad TR_3 = T_{A2} + T_{B2}$$

Another formulation for the cycle time can be now derived.

$$CT_2 = T_{A2} + T_{B2} + T_{C2} = TG_1 + TR_1$$

Hence, by generalizing the above equations we would have the following:

$$CT_k = \sum_{i=A}^N T_i = (TG + TR)_j, \forall j = \{1,2,3, \dots, M\}$$

For both intersection 1 and 2 in the actual model, and intersection 1 of the proposed solution, only two states exist. As a result the separate state timings will be equal to the green and red timing interval respectively.

### 8.3.2 System parameters

The system parameters are the characteristic parameters of the system. In a traffic control system, the parameters specific to it include the arrival rates of the cars, the departure rates, as well as the geometric capacities.

However, in the corresponding optimization study, both the vehicle arrival and departure rates do not play a large role when preparing the formulation for the optimizer. Only the maximum capacities of the roads at each control point are considered. The road capacity can be listed as shown below.

$L_{jk}$ : Max. Capacity of C. Pt(j) in intersection (k) where,

$$j = \{1,2, \dots, M\}, k = \{1,2, \dots, l\}$$

### 8.3.3 System Response variables

For the given model the response variables are as recorded:

- **Queue lengths (average and maximum)**

$LQ_{jk}$  : Queue length forming at control point (j) in intersection (k),

- **Vehicle's Waiting time**

The Average waiting time is the average time spent by the vehicle in queue until it passes the cross line of the traffic signal departing from the intersection.

$WQ_{jk}$ : average waiting time of a vehicle at control point (j) in intersection (k),

where  $j = \{1,2,3, \dots, M\}$  &  $k = \{1,2,3, \dots, l\}$

### 8.3.4 Objective Function

**Maximization of the average vehicles' time in system efficiency:**

This proposed objective function tends to maximize the average efficiency of the time a vehicle spends in the system. The time in system is the difference between the times that a vehicle enters the system in any given control point, and the time that it exits it. Based on this definition, the vehicle's time in system is to be measured at each control point for both intersections. The time in system will encompass all details about the vehicles waiting time, the average queue length, maximum queue lengths and so on.

$$\text{Max. of } z = \left( \sum_{j=1}^M \frac{\overline{TS}_{*jk}}{\overline{TS}_{jk}} \right) * \frac{1}{M}$$

where,

$$j = \{1,2, \dots, M\} \text{ and } k = \{1,2,3, \dots, x\}$$

$$\overline{TS}_{*j} = \text{best average time in system}$$

$$\overline{TS}_j = \text{actual average time in system}$$

In this equation, certain constants are calculated for  $\overline{TS}^*_j$  at each control point of both the actual and proposed solution, through a certain experimentation approach, which is described further on in this chapter.

### 8.3.5 The system's Constraints

In the analysis of any road network, the constraints would be as follows:

#### - Capacity Constraint

The maximum queue length occurring in any control point in the network should not exceed a certain characteristic limit which is the road capacity of the control point under study expressed in vehicles ( $N_j$ ). This capacity differs between every other control point in the two adjacent intersections evaluated.

$$(LQ_{max})_j \leq N_j \quad \forall j, \text{ where } j = \{1, 2, \dots, M\}$$

#### - Signal timings Constraint

There are certain logical considerations that need to be taken into account. The signal timings to be optimized should be within certain ranges. The state timings and cycle times should all have upper and lower limits that they cannot exceed. These limits are estimated based on careful field observation.

$$(T_{lower\ limit})_j \leq (TG, TR)_j \leq (T_{upper\ limit})_j,$$

$$\text{where } j = \{1, 2, \dots, M\}$$

$$(CT_{lower\ limit})_k \leq CT_k \leq (CT_{upper\ limit})_k,$$

$$\text{where } k = \{1, 2, \dots, l\}$$

The red/green signal timings constraints can be transformed to express the limits of the state timings (the problem decision variables) using the relationships previously deduced from the phase plan that relate the state timings and the signal timings. For example if  $TR_1 = T_A + T_B$ , then the constraint will be:



$$(T_{lower\ limit})_j \leq T_A + T_B \leq (T_{upper\ limit})_j$$

## 8.4 MODEL TRANSLATION



The optimization experiments in this chapter are based on maximizing the efficiency of the vehicle's average time in system. In order to compute the average time spent in the system by a vehicle in each control point, some minor modifications need to be made in the model.

A few new library blocks are added, in addition to the original model built, whether it is the actual or proposed model. For further information about the blocks used to build the traffic system model, and the model translation, refer to chapter V.

The table below represents each additional block placed in the model, or modifications made to existing blocks, to carry out the optimization process. Their purpose and function specific to the traffic system model are described. All those blocks have multiple functions and theory of operations, which can be read about in the appendix of blocks, however here they are discussed in the context of the proposed problem.

Block	Function
<b>Optimizer</b> 	Using evolutionary strategies, the optimizer searches for the best set of decision variables (state timings in this case), to maximize the time in system efficiency, considering the specified constraints
<b>Create</b> 	<p>The create block has been described before in the model translation section. However, in this chapter, an important property of the create block is changed, in order to measure the time the vehicle spends in the system.</p> <p>From the create block's options tab, a new timing attribute known as 'Time IN' is assigned to the vehicles as they enter a control point. This timing attribute will also be assigned to the respective information block, described next.</p>
<b>Information block</b> 	<p>This block is used to calculate the time that a vehicle spends in the system. It is placed in six different sections of the traffic system model, before the vehicle exits the system.</p> <p>The timing attribute established in the create block, that measures the time a vehicle enters a certain control point, must be selected in the information block's dialog.</p> <p>This means the attribute will be set to the time that the Create block generated the item, Time In. When the item arrives to the Information block, the value of that attribute will be subtracted from the current time. The difference is the vehicle cycle time.</p>



<p><b>Mean &amp; Variance</b></p> 	<p>It is used to calculate the mean of the time spent in the system reported in information block. It is connected to the cycle time output of every information block.</p>
<p><b>Equation</b></p> 	<p>This equation block is only placed at one point in the model. The traffic model consists of two intersections linked to each other. There is a point in the second intersection where the arrivals of the cars, depends on the departures of the cars in the intersection before it. Hence, an items equation block is used, to assign a new attribute Time In2, to measure the time the vehicle spends in the second intersection only.</p>

The figure below represents all the additional blocks added to the model whether it being the actual or proposed model. There are six different points in the model where the average time spent in the system by a vehicle is measured. The red squares in the figure below represent the different information blocks used to measure the vehicle's time in system at 6 different points, and each information block has a mean and variance block connected to it. Notice also the position of the equation and optimizer blocks.

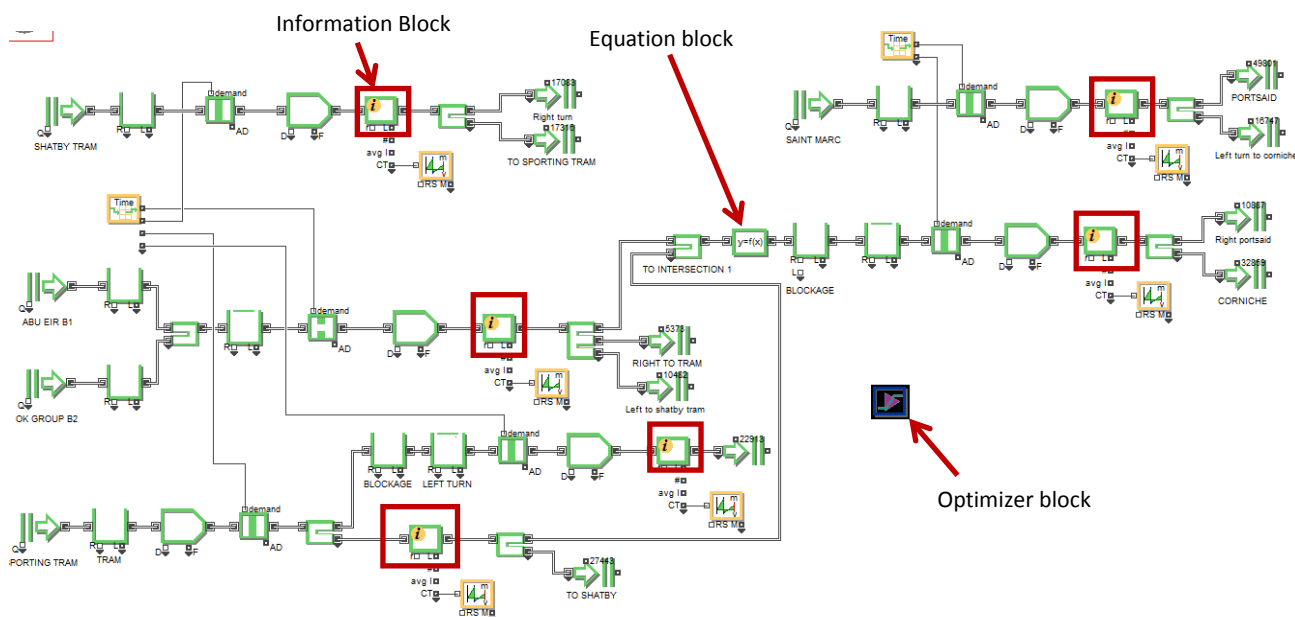

The following figure represents intersection 1 of the traffic system. It describes how the certain parameters in the equation block, as well as the create blocks are set and recognized with the information blocks.

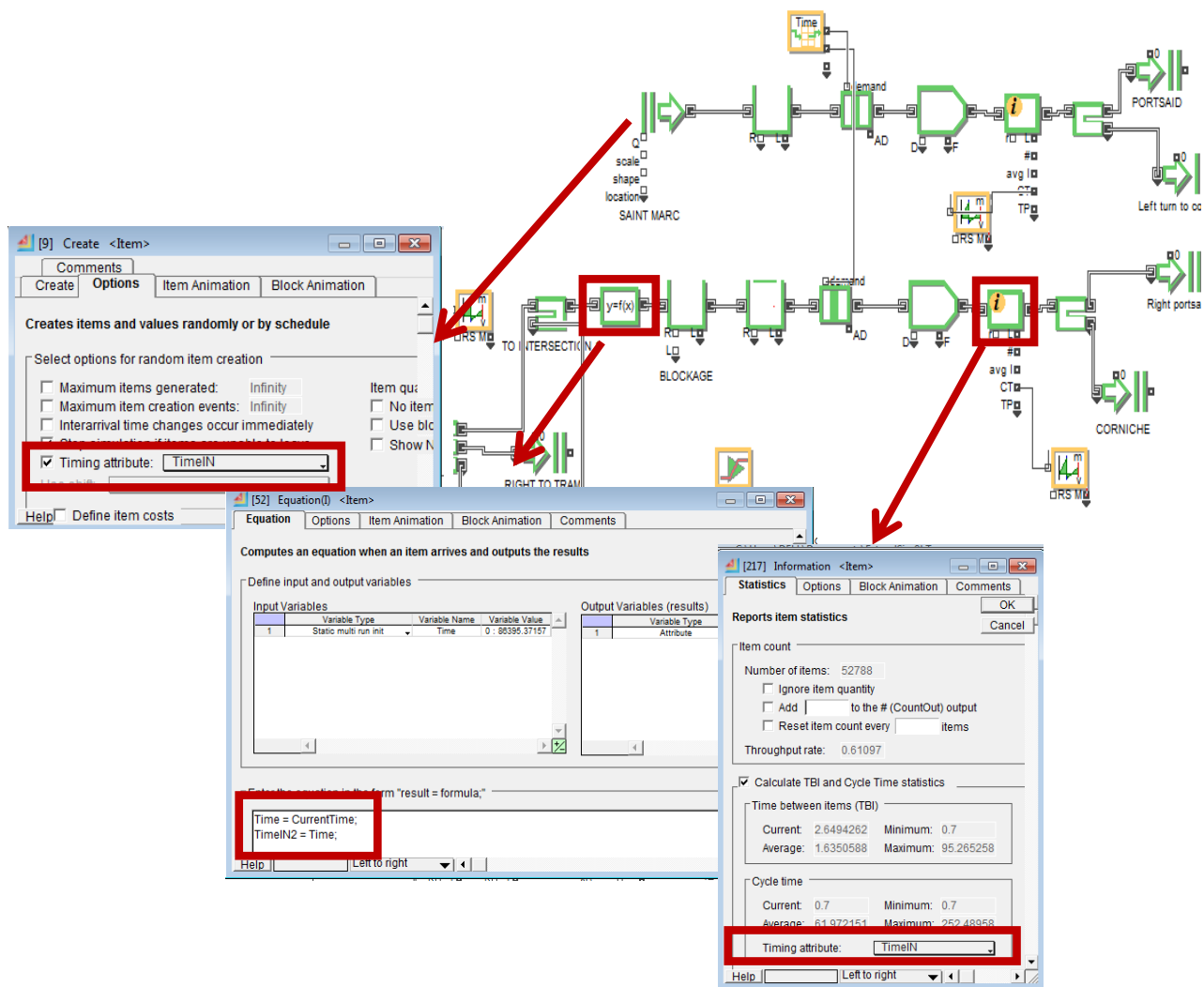

## 8.5 OPTIMIZATION OF THE ACTUAL AND PROPOSED MODEL

Optimization is carried out on both the actual and proposed models. Optimization runs have been performed for an entire complete day, as well as for every period of the day separately.

### 8.5.1 The steps for optimizing the traffic light signals

There are certain steps and procedures that need to be followed when performing optimization on a simulation model. The following steps described below are followed,

in order to optimize the model representing the traffic system of the two adjacent intersections.

The first optimization experiment was performed on the actual model, followed by experiments on the proposed solution scenario1. Nevertheless, the same general steps are applied to all optimization runs, whether it being the actual model, proposed model, or different periods of the day. The steps described are a general case applied to any optimization experiments conducted, with a few examples demonstrated to clarify the process.

### **1. Add the optimizer block to the model.**

After making all the necessary modifications to the models in order to correspond to the objective function, the optimizer block is placed from the value library and onto the model. Inside the optimizer block's objectives tab, is a variables table, for entering the all the decision and response variables. There is also an equation pane under the variables table for entering the objective function.

### **2. Determining the form of the objective function**

Before all the variables can be added to the optimizer block, the variables that are significantly important need be clarified. These variables depend on the objective function. The optimizer will try to reach a goal by changing the values of decision variables, and evaluating certain response outputs. By deciding on the basis of the objective function, the factors and variables that are to be optimized or affected by the optimization process are clarified, and therefore added to the optimizer block.

As discussed in the model formulation, the optimization experiment aims to maximize the efficiency of the average vehicle's time in system. This is achieved through a simple ratio. It is the average of the sum of the best average time in system possible for each control point divided by their respective actual time in system. This objective function is also based on a certain maximum queue length respective to the road capacity that cannot be exceeded for each control point.

$$Max. of z = (\sum_{j=1}^M \frac{\overline{TS}^*_{jk}}{\overline{TS}_{jk}}) * \frac{1}{M}$$

where,

$$j = \{1,2, \dots, M\} \text{ and } k = \{1,2,3, \dots, l\}$$

$$\overline{TS}^*_j = \text{best average time in system}$$

$$\overline{TS}_j = \text{actual average time in system}$$

The best times in the system need to be measured, and are used as constants in the objective function equation. This is done through a trial and error process, where for each control point, the best conditions are set. In order to achieve the shortest time that vehicle can spend in the system, the time that traffic light is green is increased, and the time that it is red is decreased. In addition, for the actual model the exception gate in intersection 2 is removed to prevent any vehicles turning left during Abo Eir's green time. Chapter V can be referred where the model is translated and described, and the concept can be better clarified.

The procedure is repeated for all control points in all the models one at a time, with identical conditions each time, assigning 100 seconds for green light, and 20 for red light. The average time the vehicle spends in the system is observed for each section and noted down. Those constants differ from each model, depending on the period of the day that the model represents. Figure 8-1 is an example of the numbers recorded in an excel sheet, for the proposed scenario in the first period.

	A	B	C	D
1				
2	SCENARIO 1			
3	control points	Best CT		
4	1	10		
5	2	7.6		
6	3	2.2		
7	4	6		
8	5	2.2		
9	6	2.7		
10				

**Figure 8-1: Calculation of CTbest in optimization using simulation**

### 3. Determine all the variables the objective function needs, and add them to the optimizer block

Any variables and parameters are placed into the optimizer block by a process known as clone dropping. It simply uses a clone button, to drag clones of the desired variables, into the optimization block. This allows the optimizer block to read and change values of that variable in the model, allowing it to explore different feasible solutions during the run.

As discussed in greater detail before, the decision variables in this case are both the state timings and cycle times for the two intersections, differing and depending on the phase plan of either the actual or scenario 1 models. The response variables are the average time in system for each segment of the system, as well as the maximum queue lengths forming at each control point. The maximum capacities of each control point need to be considered.

The list below represents all the different variables that are placed into the optimizer block, and how they are named, for the actual model, as an example. For the proposed model, there will be one additional decision variable,  $T2_b$  in intersection 2. Refer back to the model formulation section of this chapter to better remember what each variable stands for.

- For intersection 1 there are the two decision variables,  $T1_a$  and  $CT_a$  where:

$$T1_a = T_{A1}$$

$$CT_a = T_{A1} + T_{B1}$$

- For intersection 2 there are also two decision variables,  $T1_b$  and  $CT_b$  where:

$$T1_b = T_{A2}$$

$$CT_b = T_{A2} + T_{B2}$$

- There are nine different response variables throughout the entire system, indicating the maximum queue length at each control point represented as:

$MQ_1, MQ_2, MQ_3, MQ_4, MQ_5,$  and  $MQ_6,$  where,  $MQ_1 = MQ_{1a} + MQ_{1b} + MQ_{1c}$

- There are six other different response variables indicating the average vehicle time spent by the vehicle at each segment of the traffic system, and they are represented in the optimizer block as follows:

$$aveCT_1, aveCT_2, aveCT_3, aveCT_4, aveCT_5, \text{ and } aveCT_6$$

Figure 8-2 represents the position of the different control points for the proposed phase plan. This clarifies which segments in the intersections the response variables are obtained from. The numbers on the layout, correspond to the numbers found in the response variables names. 2' and 1' represent the numbers 5 and 6 respectively.

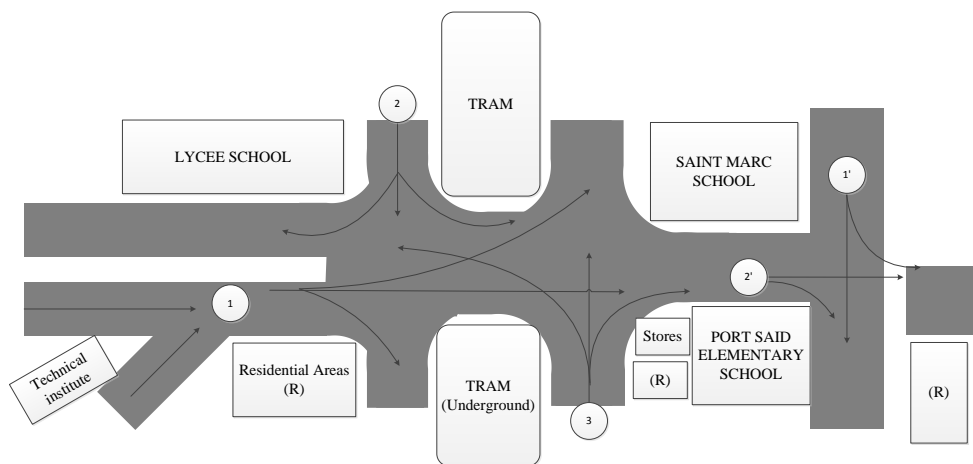

**Figure 8-2: Layout of the intersection under study in optimization using simulation**

Using the clone layer tool, all the variables are dragged onto the optimizer block. Once the optimizer block's icon is highlighted, the mouse can be released, and this ensures that the variables have been successfully placed. The name of the variable is also changed as required.

For the case of cloning a variable contained in a table, the entire table must be cloned and dropped into the optimizer and the row and column indexes need to be entered and separated by a comma. Take for instance the cumulative state timings, they are found in a lookup table. This block is opened, and using the clone layer, the data table in the dialog box containing all the state timings is dragged onto the closed optimizer block.

The row and column within the optimizer block must be determined for this table, to indicate the cell to use. In the case of intersection 2, there are two state timings, of both

A and B to be cloned, with coordinates of (1, 0) and (2, 0) respectively. This process is repeated for ALL decision variables found in look up tables.

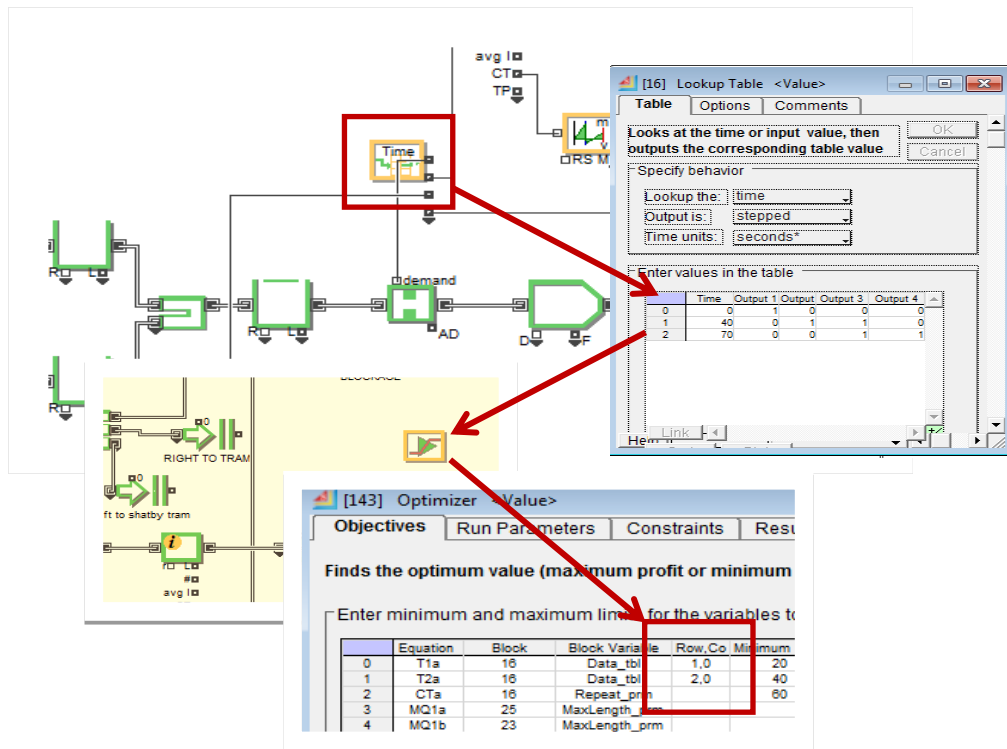

As for single parameters, such as the maximum queue lengths at each control point, and the average cycle times, the dialogue box for each queue or information block is opened, and the single value representing the variable is directly cloned onto the closed optimizer block, without having to determine the row or column.

The figure below describes the process of cloning the maximum queue length from a queue block and into the optimizer. The same is done for all the maximum queue lengths and average time in the system. The average time in system are collected from the mean and variance block.

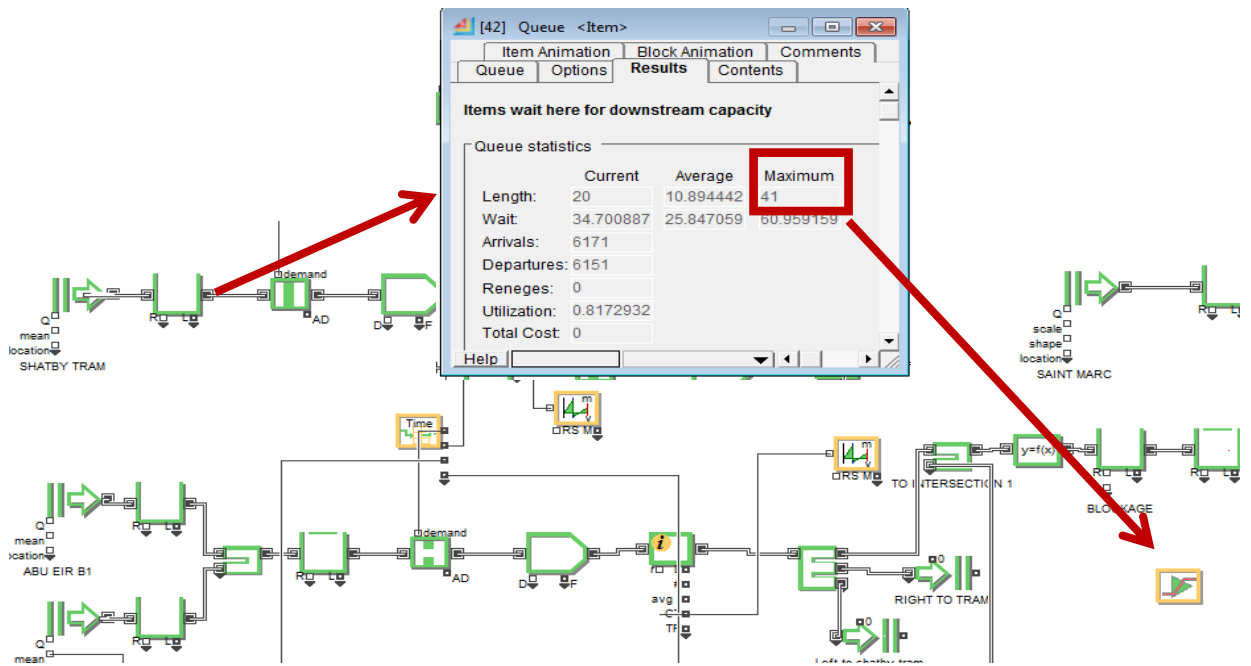

The clone dropping process is continued, until all the variables are placed into the optimizer block.

#### 4. Setting the limits for the variables

This step is a vital step in order to allow the optimizer to differentiate between both the decision variables, and the system parameters or response variables.

The variables that the optimizer will try to change are those that have specified limits set for them. As for the variables without limits, they are considered to be outputs from the simulation, and the optimizer will not try to change them. Therefore, it is necessary that after all the decision variables are cloned, their maximum and minimum limits are set.

Logically, the traffic signal lighting time should not be smaller than 20 seconds, neither larger than 90 seconds, as usually the time set on the digital screen is a 2 digit number. Below is an example on the limits set for the decision variables for the actual model:

- $20 \leq T1_a \leq 90$
- $40 \leq CT_a \leq 180$
- $20 \leq T2_a \leq 90$
- $60 \leq CT_b \leq 270$



The figure below represents how those limits should be entered in the optimizer objectives tab.

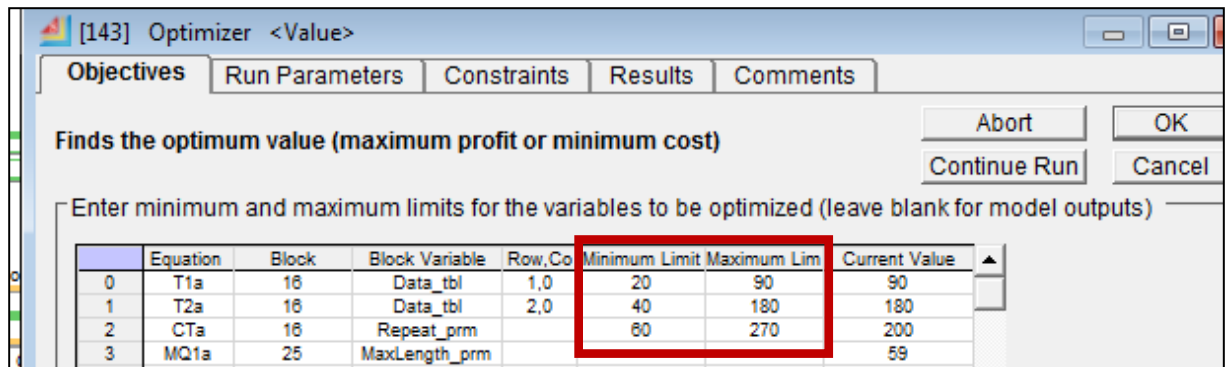

### 5. Entering the objective function

At this stage, all the variables are clarified, and all the limits are entered. The objective function can now be entered in the standard form in the equation pane. The objective functions can minimize cost or maximize profit such as in the case of this experiment. The profit is maximized, because as the shortest average time in system is divided by a smaller actual average time in system, than the profit increases and vice versa.

In this optimization experiment, the objective function is written in the form of an IF ELSE equation. As mentioned before, the vehicle's time in system in general depend on the maximum queue length or capacity allowed for each control point, therefore soft constraints specifying maximum number of vehicles in queue must be placed.

The objection function states that if any of the maximum queue lengths set are exceeded, than the maximum profit will equal the average of the sum of the best average times in system divided by their respective actual average time in system, for every given control point. Otherwise, if the soft constraints are satisfied, then the maximum profit is equal to the former, but multiplied by 100. The maximum queue lengths for each queue in the system are represented in Figure 8-3.

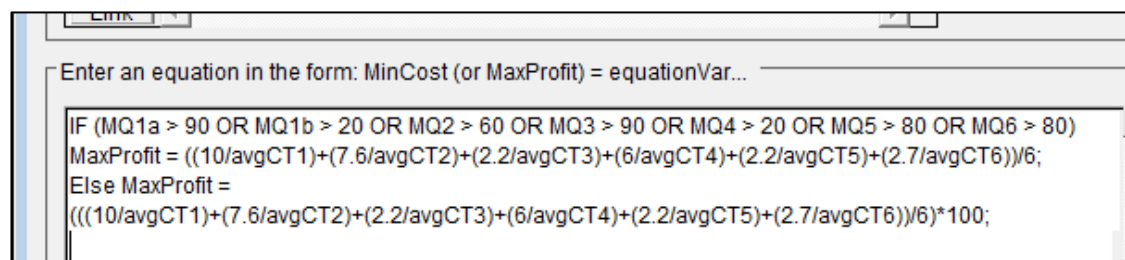

Figure 8-3: The objective function of the optimization using simulation model

By multiplying the equation by 100, the value of the maximum profit is increased, hence giving the profit with its respective timings greater priority.

## 6. Adding the model constraints

By constraining a certain parameter, the values that fall outside those boundaries are not considered as part of the possible solution space. Those constraints can be hard in their nature, and added in the form of equations in the optimizer's constraints tab, or as with the case of preceding soft constraints described above, within the equation pane along with the objective function.

There are two types of constraints, individual and global constraints. Individual constraints are applied to specific variables, causing them to be changed in some manner. Whereas the global constraints cause an entire set of parameters to be rejected, triggering the optimizer to try a different set. For global constraints, a special variable "reject" is used. If the reject variable is set to TRUE, it will reject that case. If the reject is not set to TRUE, then the current case will be used for the next series of runs.

As described in the model formulation segment previously, the constraints on the model are applied to the signal timings. They should be optimized within certain ranges, and should not exceed specified limits. In order to do so, global constraints were written as the following equations for the actual model. The difference between two state timings has to be within a certain range.

- $IF ((CT_a - T1_a) < 20) Reject = TRUE$
- $IF ((CT_a - T1_a) > 90) Reject = TRUE$
- $IF ((CT_b - T2_b) > 90) Reject = TRUE$
- $IF ((CT_b - T2_b) < 20) Reject = TRUE$

Realistically, no pre timed traffic light signal, will be green/red for only 10 seconds, and no traffic light signal is composed of a 3 digit number. Therefore, the minimum difference between two state timing should be 20 seconds, and the maximum difference is 90 seconds.

In addition to those global constraints, some individual constraints are set. Through field observation, all of the traffic signal timings were multiples of 10. Numbers such as 99 seconds or 25 seconds were never detected. In order to ensure the fact that the timings optimized are all divisible by 10, the constraint is written in the following equation form for all the decision variables just discussed previously:

$$T_{ik} = 10 * \left[ \text{round} \left( \left( \frac{T_n}{10} \right), 1 \right) \right]$$

After entering all the equations in the optimizer block, the constraints tab should look like Figure 8-4

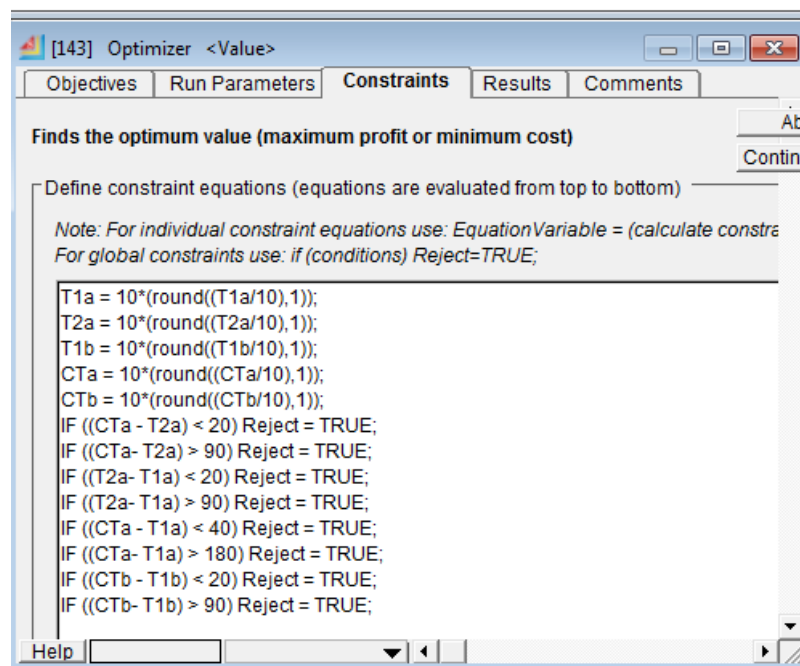

Figure 8-4: Constraints within the optimizer block in optimization using simulation model

## 7. Running the optimizer

There are two defaults for the run parameters in the optimizer block, the better defaults and the quicker defaults. These options can be set from the run parameters tab in the optimizer's dialog.

Generally the quicker default is used as a preliminary optimization trial, to test a process or determine any possible mistakes and complications. This type of run sets up all the parameters for a random model that needs multiple samples to be tried, yet at the same time limits the number of samples by default so that the run is quicker, and results can be collected in a shorter time frame. If the quicker defaults cannot find any feasible

solutions, then better defaults are tried. The better results they increase the number of samples, as a result increasing the time of run.

There are two other parameters that are especially important to the convergence of the optimization, the maximum samples per case, and when to terminate the run.

- The maximum samples per case are simply the maximum number of runs averaged to get a result. For random models such as the one under study, this number needs to be high enough to get a useful value. In the quicker defaults, a maximum of 5 samples is run, whereas for the better defaults it is 100.
- Terminate if the best and worst within (%): this value is used to examine the current population of the results, to see if they are within a specified percentage of each other. This percentage causes the optimization process to continue until the population converges closely to that value, increasing the chances of a more optimum answer. For quicker defaults, the optimization terminates when the best and worst results are within 0.9, and for the better results it is at 0.995.

The optimizer also checks the convergence after a certain number of specified cases. Figure 8-5 displayed below represents the run parameters, for the quicker default of a random model.

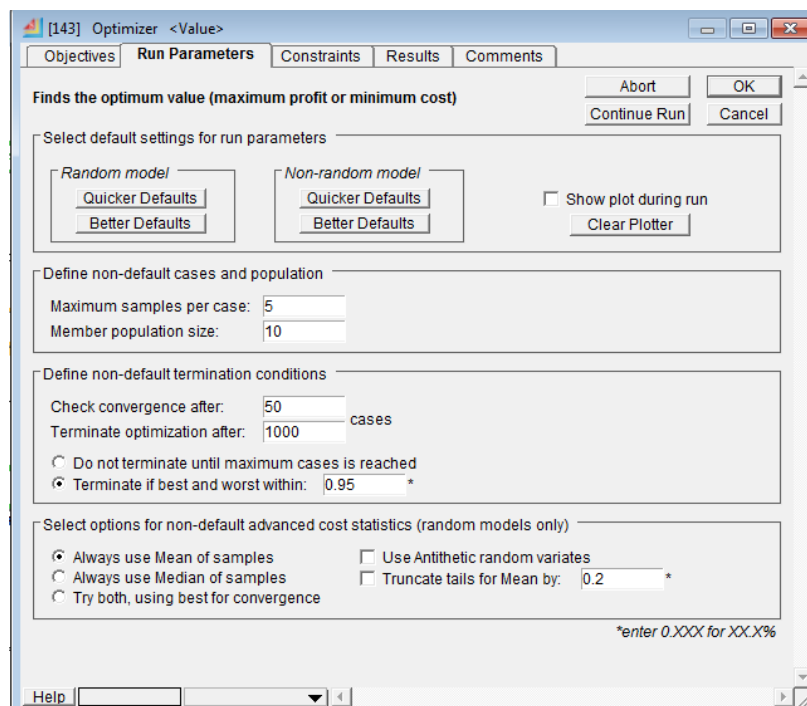

Figure 8-5: run parameters in the optimization using simulation model

The optimization is run by clicking new run in the optimizer's dialog. As the optimization process takes place, the optimizer sorts the results based on the objective function, which is to maximize the profit, and better solutions replace inferior solutions in the population table. Therefore the results are always arranged in descending order.

After the run is terminated at a certain convergence, the results appear in the same way represented in the figure 8-6.

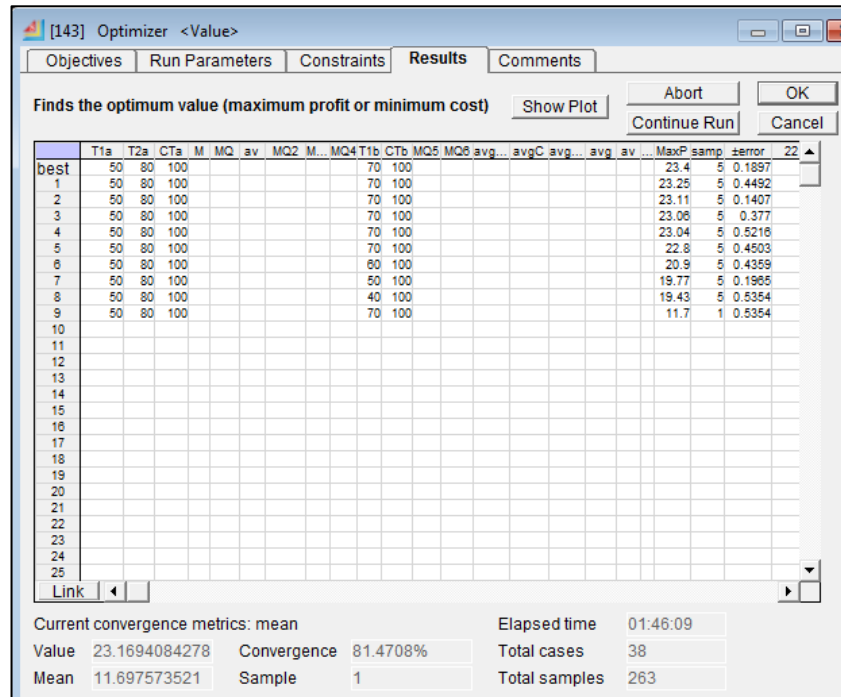

Figure 8-6: results found in the optimizer block in optimization using simulation model

## 8. Interpreting the results

The results tab will show the entire population of solutions resulting from the optimization run, sorted with the best solution in the first row.

The only values shown are for the decision variables results, as the optimizer tries different values for the state timings and cycle times. Results are also displayed for the maximum profit resulting from the optimization run. All the other variables are blank as they are outputs from the run.

The best solution set for the selected parameters or decision variables are automatically placed into the model, so that a simulation run can be performed, to evaluate the performance of the optimized traffic system.

## 8.6 EXPERIMENTATION AND RESULTS

### 8.6.1 Optimization of the traffic light signals for the actual model

#### Optimization of the entire day

The first optimization run was performed on the actual model, using both quicker and better defaults. It was run for the entire day with the differing arrival rates for all periods. Since the pre-timed system in Alexandria in reality is incorrectly applied and the timings are set randomly, trying to find one set of optimum signal timings to be fixed throughout the entire day is thought to be appropriate for the current real case.

However, whilst interpreting the results, it was discovered that no feasible solutions have been found. The maximum profit is a small number as shown in the figure below, indicating that the soft capacity constraints entered in the objective function have been violated, and the optimizer was unable to find a solution to satisfy the entered capacities.

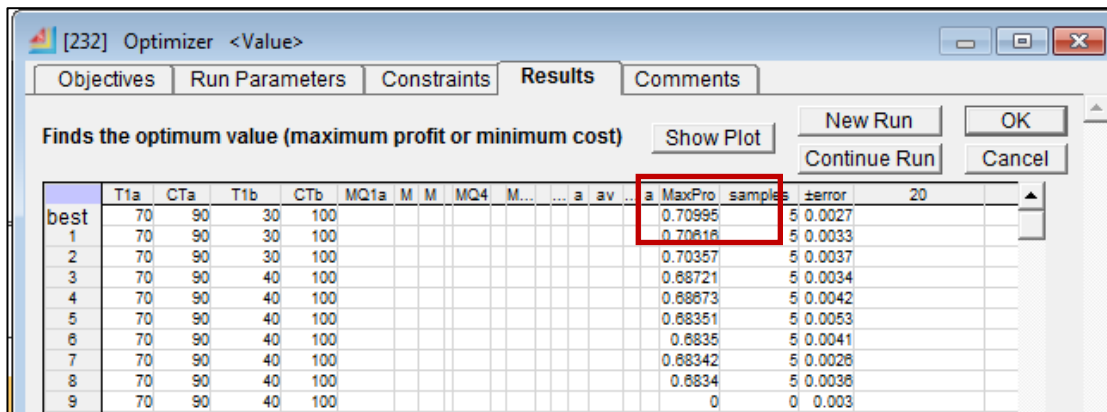

	T1a	CTa	T1b	CTb	MQ1a	M	M	MQ4	M	a	av	a MaxPro	samples	error	20
best	70	90	30	100								0.70995	5	0.0027	
1	70	90	30	100								0.70616	5	0.0033	
2	70	90	30	100								0.70357	5	0.0037	
3	70	90	40	100								0.68721	5	0.0034	
4	70	90	40	100								0.68673	5	0.0042	
5	70	90	40	100								0.68351	5	0.0053	
6	70	90	40	100								0.6835	5	0.0041	
7	70	90	40	100								0.68342	5	0.0028	
8	70	90	40	100								0.6834	5	0.0036	
9	70	90	40	100								0	0	0.003	

This is a logical result, and it indicates that in fact the real system and management of the intersection under study is operating incorrectly, as a result creating extreme traffic congestion.

#### Optimization of the individual periods

As a solution to this problem, different models were replicated. Each one represents a different period of the day. As covered before in the report, each period of the day has

different vehicle demand and arrival rates, therefore each one of the models has different arrival rates, ones that correspond to the period of the day it represents.

Since there are no feasible solutions to fixed signal timings throughout the day as a whole, this experiment aims to apply a correct pre-timed system. In this case the traffic signal timings are fixed and pre-determined. However, every period of the day has its own set of fixed timings, corresponding to the vehicle demand during that period. As the day has previously been classified into 5 different periods in the report, 5 different models were run.

Table 8-1 represents the results obtained for periods 1,2,3,4, and 5, of the actual model. They are all summarized indicating the different values obtained for the decision variables and the maximum profit corresponding to those timings.

Note that for period 1 and 3, the maximum profit is a small number. This is because the optimizer has been unable to reach a feasible set of solutions for the signal timings, that satisfy all the constraints entered. Again, those results make logical sense since period 1 and 3 are the two peak periods with the highest arrival throughout the day, probably representing long queue lengths.

**Table 8-1: State timings obtained in optimization of actual model**

PERIOD		1	2	3	4	5
Int. 2	$T1_b$	80	50	80	80	80
	$CT_b$	100	70	100	100	100
Int. 1	$T1_a$	80	20	80	70	20
	$CT_a$	100	100	100	90	100
Max. profit		0.638	79.5	0.62	87.5	78.5

Table 8-2 represents the conversion of those values into the actual state timings using the equations and relationships stated and explained earlier on in this chapter, in the step of entering the decision variables into the optimizer block.

**Table 8-2: State timings obtained in optimization of actual model**

			Period				
Int.	State	Timing	1	2	3	4	5
2	A	$T_A$	80	50	80	80	80
	B	$T_B$	20	20	20	20	20
	Cycle time			100	70	100	100
1	A'	$T_{A'}$	80	20	80	70	20
	B'	$T_{B'}$	20	80	20	20	20
	Cycle time			100	100	100	90

Using the equations and relationships that link the state timings with signal timings, the actual red and green timings that are to be displayed on the traffic light signals are calculated. Such a conversion is briefly described in this chapter in the model formulation section. For greater knowledge about the derivation of such equations, refer to chapter IV. Table 8-3 summarizes the red and green timings.

**Table 8-3: red and green timings obtained through optimization of actual model**

			Period				
Int.	C.P.	Timing	7-9am	9-1pm	1-5pm	5-11pm	11-7am
2	1	$TG_1, TR_1$	20, 80	20, 50	20, 80	20, 80	20, 80
	2	$TG_2, TR_2$	80, 20	50, 20	80, 20	80, 20	80, 20
	3	$TG_3, TR_3$	80, 20	50, 20	20, 80	80, 20	80, 20
Cycle time			100	70	100	100	100
1	1'	$TG_{1'}, TR_{1'}$		20, 80	20, 80	70, 20	20, 20
	2'	$TG_{2'}, TR_{2'}$		80, 20	80, 20	20, 70	20, 20
	Cycle time				100	100	90

The results obtained from evaluating and measuring the systems performance for each optimized model and time period were noted on an excel sheet, and summarized in tables 8-4 and 8-5. The average queue lengths and average waiting times for each control point and period are represented in the first table and average vehicle time in system in the second. For the layout of the intersections and the position of the control points, chapter VI or VII can be referenced.



**Table 8-4: performance metrics from the optimization using simulation of actual model**

		Period									
		7-9am		9-1pm		1-5pm		5-11pm		11-7am	
Int.	CP.	$LQ_{av}$	$WQ_{av}$	$LQ_{av}$	$WQ_{av}$	$LQ_{av}$	$WQ_{av}$	$LQ_{av}$	$WQ_{av}$	$LQ_{av}$	$WQ_{av}$
2	1 B1	4.5	13.6	1	2.6	6821	20457	0.02	0.13	0.007	0.07
	1 B2	3.6	13.6	0.5	2.6	4192	15440	0.02	0.15	0.006	0.07
	1 both	13	21.8	9.4	15.4	20	56	6.5	27	5.9	31.9
	2	1.1	2.6	1.4	3.6	1.04	2.6	1.1	2.8	0.4	2.2
	3	2.2	2.2	2	3	2.2	2.2	1.2	2.3	0.5	2.1
	4	2.8	5.6	0.7	2.2	2.8	5.6	0.2	0.8	0.01	0.1
1	1'	14.2	25.9	1.7	3.6	13.3	30.9	8.8	35.7	25.6	37
	2'	2.1	2.4	29	37.8	1.9	2.4	2.3	2.4	0.42	2.7

**Table 8-5: performance metrics (2) from optimization using simulation of actual model**

		Period				
		7-9am	9-1pm	1-5pm	5-11pm	11-7am
Int.	CP.	$TS_{av}$	$TS_{av}$	$TS_{av}$	$TS_{av}$	$TS_{av}$
2	1	35.4	18	17994	27.1	31.96
	2	3.1	4.1	3.1	3.3	2.7
	3	2.4	3.3	2.5	3.3	2.2
	4	14.8	14	14.9	12.8	13.2
1	1'	26	3.8	31	36	37.2
	2'	2.6	40	2.6	2.6	2.9

**The optimized actual model versus the actual model**

By finding the average of the average Queue lengths, waiting times, and vehicle cycle times for the entire traffic system, at each period of the day and combining this data, the percentage improvement of the certain parameters is calculated. Comparisons are made between the performance of the actual system using the current traffic signals, and the optimized actual model.

The equations used to measure the percentage are as listed.

$$- \text{ \% reduction in } LQ_{avg} = \frac{LQ_{avg1} - LQ_{avg2}}{LQ_{avg1}}$$

$$- \text{ \% reduction in } WQ_{avg} = \frac{WQ_{avg1} - WQ_{avg2}}{WQ_{avg1}}$$

$$- \text{ \% reduction in } TS_{avg} = \frac{TS_{avg1} - TS_{avg2}}{TS_{avg1}}$$

Table 8-6 represents the improvement percentages.

**Table 8-6: Improvement percentages obtained**

Periods	% improvement of avg. TS	% improvement of avg. LQ	% improvement of avg. WQ
1	35	75	69.6
2	42.5	6.7	38.4
3	-13.9	-3722	-12355
4	61.7	66.5	68.1
5	26.8	-173	13.2

Note that there are large negative percentages. This means that no improvements have been made in the overall system, but rather an increase in the queue lengths, waiting times and times in system. This is due to the fact that the optimizer was unable to reach a feasible solution for period 3. However, despite the fact that the optimizer was also unable to reach the best or optimum solution for period 1, there has been an improvement in the systems performance in all parameters, when compared with the real performance of the adjacent intersections.

Since a couple of the periods produced infeasible solutions, comparing those results with the actual performance obviously shows slight improvement at certain control points, and major problems in others. Such comparison is not really practical or accurate. There is no basis or criteria for comparisons. This is why the results of the optimization of the proposed scenario offer greater importance.

## **8.6.2 Optimization of the traffic light signal's results for the proposed solution (scenario 1)**

The second optimization experiment aims counteract the problems faced when optimizing the actual model. Therefore it was thought appropriate to try and optimize the modified traffic model, which is scenario 1. In order to understand the difference between both the proposed and actual models, both specific to the theory of operation and model translation, refer to chapters V and VI.

Briefly, this difference between them is basically the phase plan for intersection 2. An additional control point is added in intersection 2 in order to manage the flow of the vehicles turning left from Sporting tram to Abo Eir, and to minimize any blockage occurring.

The same exact steps that have been described for the optimization process on ExtendSim8 are repeated for the proposed model of the traffic system under investigation. The steps are repeated specific to this model.

The model is modified and adjusted, for the entire day and for every period. The same objective function is used, in order to try to maximize the average vehicle time in system efficiency. All the decision variables and response variables specific to the proposed model are cloned and named in an identical manner, and the same limits and constraints are entered.

### **Optimization of the entire day**

Again, the first optimization run was for the entire day, in order to see if there was one set of traffic signal lightings that would be appropriate for all 5 periods of the day. However, as expected the results of this optimization run also represented an infeasible solution, and the optimizer couldn't reach a better/optimum solution for the problem, that satisfied all the constraints described before.

## Optimization of the individual periods

Following that, better default optimization runs were carried out for each period separately, representing the following results enumerated in summary Table 8-7. Those results are feasible and are able to satisfy the all the constraints.

**Table 8-7: Results of optimization using simulation of scenario 1**

PERIOD		1	2	3	4	5
Int. 2	$T1_b$	40	20	40	20	20
	$T2_b$	80	40	70	70	40
	$CT_b$	100	60	90	90	100
Int. 1	$T1_a$	80	80	20	70	80
	$CT_a$	100	100	100	90	100
Max. profit		34.79	46.03	35.07	39.59	42.72

Table 8-8 represents the conversion of those values into the actual state timings.

**Table 8-8: State timings obtained through optimization using simulation of scenario 1**

			Period				
Int.	State	Timing	1	2	3	4	5
2	A	$T_A$	40	20	40	20	20
	B	$T_B$	20	20	30	50	60
	C	$T_C$	20	20	20	20	20
	Cycle time			80	60	90	90
1	A'	$T_{A'}$	80	80	20	70	80
	B'	$T_{B'}$	20	20	80	20	20
	Cycle time			100	100	100	90

Using the equations and relationships briefly described in this chapter during the model formulation section, the actual red and green timings that are to be displayed on the traffic light signals are calculated. Table 8-9 is the one that summarizes the red and green timings.

**Table 8-9: Signal timings obtained through optimization using simulation of scenario 1**

			Period				
Int.	C.P.	Timing	7-9am	9-1pm	1-5pm	5-11pm	11-7am
2	1	$TG_1, TR_1$	40, 40	20, 40	40, 50	20, 70	20, 80
	2	$TG_2, TR_2$	20, 60	20, 40	30, 60	50, 40	60, 40
	3	$TG_3, TR_3$	40, 20	40, 20	50, 40	70, 20	80, 20
	4	$TG_4, TR_4$	20, 60	20, 40	20, 70	20, 70	20, 80
Cycle time			80	60	90	90	100
1	1'	$TG_{1'}, TR_{1'}$	80, 20	80, 20	20, 80	70, 20	80, 20
	2'	$TG_{2'}, TR_{2'}$	20, 80	20, 80	80, 20	20, 70	20, 80
	Cycle time			100	100	100	90

The results obtained from evaluating the systems performance for each optimized model are summarized in tables 8-10 and 8-11. The average queue lengths and average waiting times for each control point and period are represented in the first table, and average vehicle's times in system in the second.

**Table 8-10: performance metrics for optimization using simulation of scenario 1**

		Period									
		7-9am		9-1pm		1-5pm		5-11pm		11-7am	
Int.	CP.	$lQ$	$WQ$	$lQ$	$WQ$	$lQ$	$WQ$	$lQ$	$WQ$	$lQ$	$WQ$
2	1 B1	1.04	3.1	1.6	3.9	0.9	2.7	0.03	0.2	0.009	0.09
	1 B2	0.6	3.86	0.7	3.2	0.7	2.7	0.02	0.2	0.005	0.07
	1 both	10.2	20.8	12.9	21.1	10.3	17.3	7.6	30	6.4	35.2
	2	9.8	22.9	6.7	16.8	10.6	25.6	4.34	11.1	7.1	35.6
	3	9,7	9.6	2.3	3.5	10.8	10.8	1	2.1	0.4	1.5
	4	6.8	17.2	2.5	9.5	5.4	13.5	5	24.8	0.6	5.9
1	1'	27	2.4	18.4	36.3	1.3	2.4	12.9	55.4	10.6	67
	2'	2.06	58.6	1.8	2.3	30.5	38	2.5	2.7	1.6	2.3

**Table 8-11: performance metrics (2) of optimization using simulation of scenario 1**

		Period				
		7-9am	9-1pm	1-5pm	5-11pm	11-7am
Int.	CP.	$TS_{av}$	$TS_{av}$	$TS_{av}$	$TS_{av}$	$TS_{av}$
2	1	24.7	10.6	1.3	31.6	31.6
	2	23.5	17.3	26	11.6	11.6
	3	10.2	4.1	11.5	2.7	2.7
	4	32.3	13.6	27.4	27.5	27.5
1	1'	58.7	36.4	2.6	55.6	55.6
	2'	2.6	2.5	38.2	2.9	2.9

**Optimized Scenario 1 versus the actual model**

The percentage improvements were also calculated for the proposed model, in the same manner for the optimized actual model. Table 8-12 represents those percentages.

**Table 8-12: Values of percentage improvement in optimized scenario 1**

Periods	% improvement of avg. TS	% improvement of avg. LQ	% improvement of avg. WQ
1	35	62	35.3
2	42	4.2	16
3	99.3	65.8	60.9
4	2	44.5	43.5
5	-23	-120	-68.4

The only period that did not manage to reduce the overall system’s average times in system, queue lengths and waiting times was the last period. However, the percentage increase is not massive, and does not offer a great threat of traffic congestion. Despite the increase, the results have been received through the optimization experiment are feasible, and satisfy all constraints. The rest of the periods show great results. This will be clarified further in the graphs below.

In order to visually and clearly compare the outputs and improvements of different parameters of each period of the day, graphs are used. The graphs below represent those

different comparisons. All comparisons are made against the real performance of the actual simulated model.

The chart in Figure 8-6 compares the performance of the real system with that of the optimized solution approach, based on the average queue length at each control point.

An average of the average queue lengths at each control point has been calculated, to compare the improvement in the overall traffic system. It is clear that there has been significant improvement more or less for the peak time periods, which represented the biggest problems to start with.

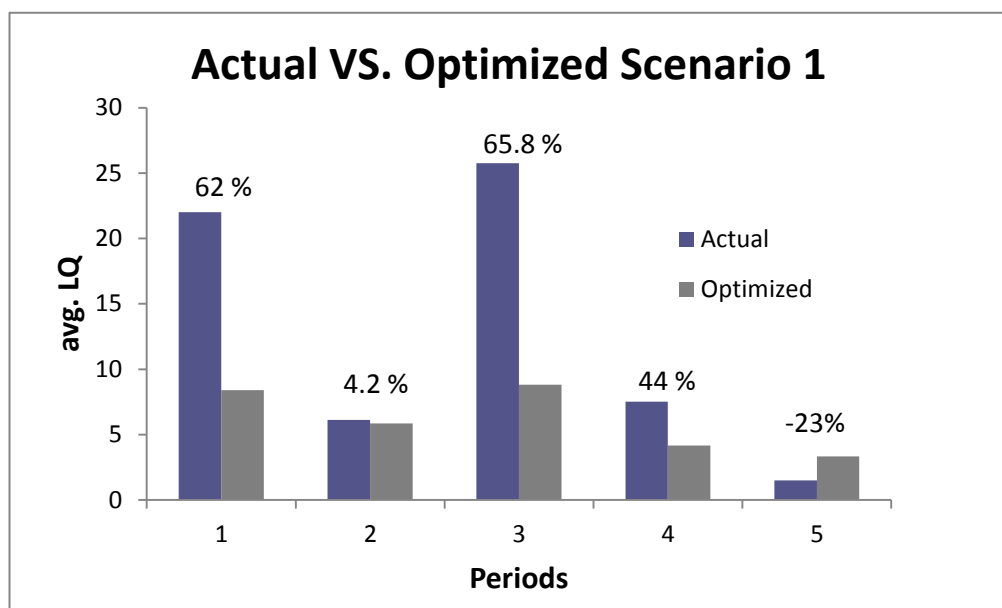

**Figure 8-6: Actual vs. optimized scenario 1 in terms of LQav**

The chart in Figure 8-7 compares the improvement based on the average of the average waiting time in the system for each period of the day at every control point. Again significant improvements are seen for the peak periods, despite the fact that for period 5 no improvement was made.

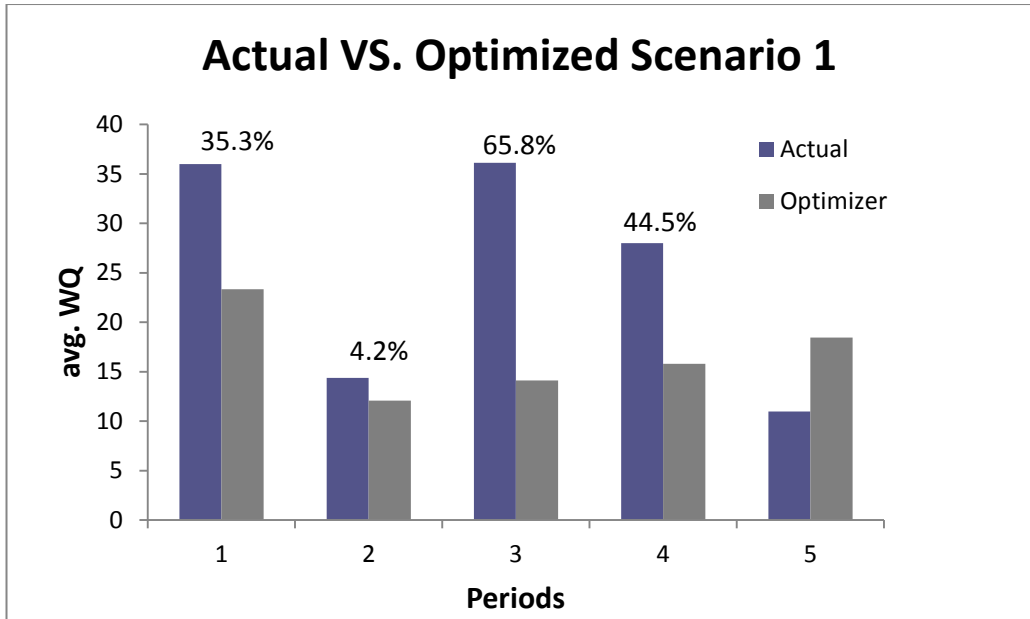

Figure 8-7: Actual vs. optimized scenario1 in terms of WQav

This third comparison in Figure 8-8 is made based on a function of average of the average queue lengths multiplied by the average waiting time in queue. For periods 1 and 2 again, there is a great reduction, whereas for period 5, there hasn't been an improvement made. Regardless, the increases provided by periods 5 are very little and do not cause major problems.

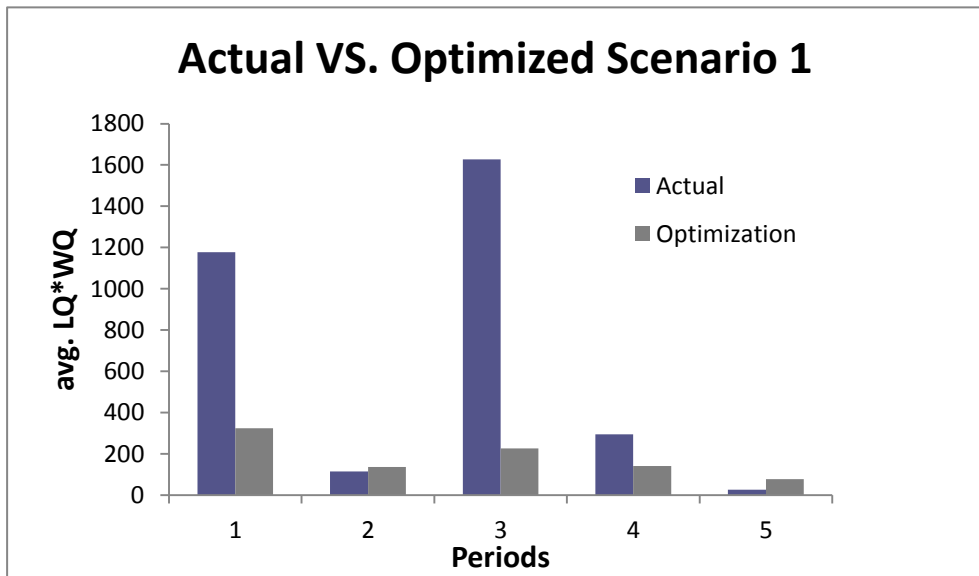

Figure 8-8: Actual vs. optimized scenario1 in terms of (LQav \* WQav)



For this last graph, a comparison is made based on the average of the average vehicle time in system. The bars represent the percentage reduction of the time in system between the optimized scenario and the actual performance. Significant reduction of the time the vehicle spends in the system is seen for period 3. The rest of the periods show good improvements too, except for again the last period. Nonetheless, it represents an extremely small increase of the time in system. The data points are illustrated on the graph shown in Figure 8-9 to clarify the comparison.

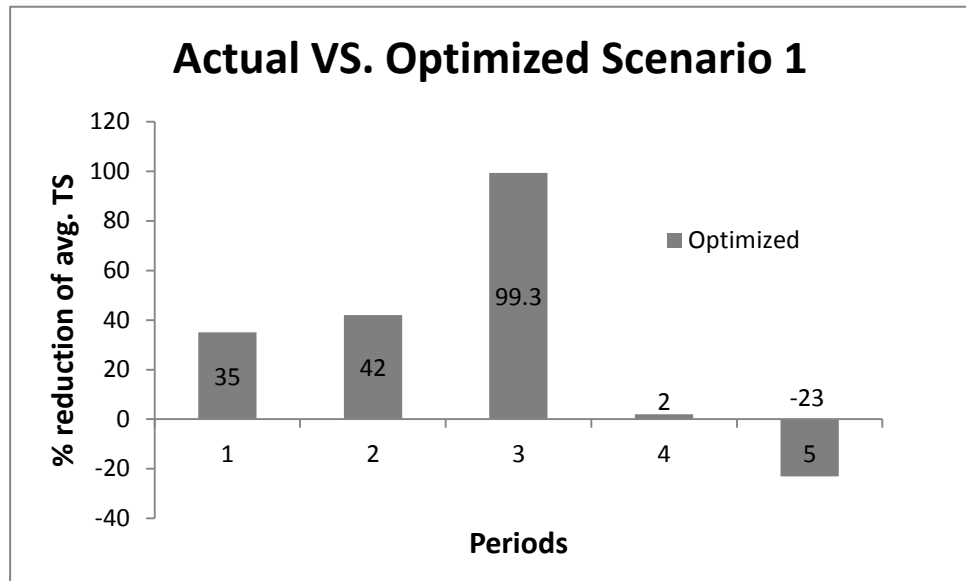
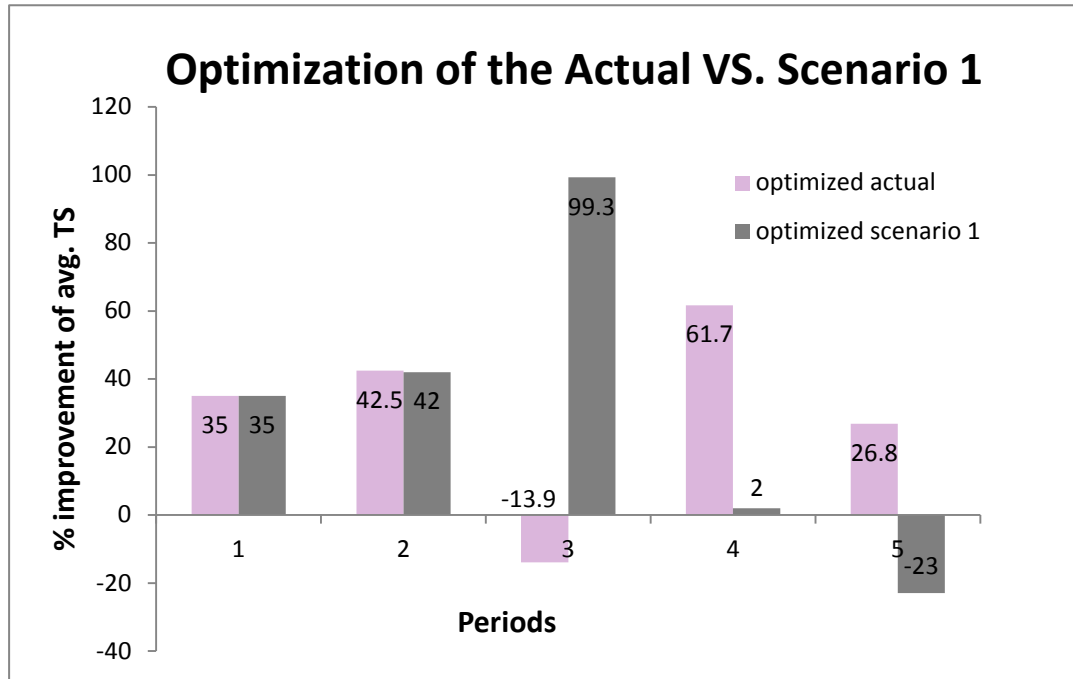

Figure 8-9: Actual vs. optimized scenario 1 in terms of TSav

### 8.6.3 Comparing the optimization results for the actual model and scenario 1

The improvements in the average of the average queue lengths, average waiting times and average vehicle time in system, were relatively greater for the optimized proposed solution as compared to the optimized actual model in major periods such as the PEAK times; therefore the optimized proposed models should be considered as an actual solution.

The graph in Figure 8-10 is an example of this statement. It compares the percentage improvement of the average time in system of the entire system for each period of the day, relative to the real performance of the system, for both optimized models. Comparisons made to the other parameters show a similar pattern too.



**Figure 8-10: optimized actual vs. optimized scenario 1 in terms of TSav**

As observed from the graph, periods 1 and 2 for both models present very similar improvements. However, in period 3, which is one of the important periods of the day, for scenario 1 shows a massive reduction of the time in system, whereas the actual model represents an increase of the average time in system. Furthermore, despite the better improvement for the actual model in periods 4 and 5, it can be concluded that the improvements in all the other periods for scenario 1 can counteract those differences. In addition, the optimum signal timings achieved in scenario 1, were able to overcome problems for the two peak time periods (period 1 and 2) which are of extreme importance.

#### **8.6.4 Overall percentage improvement**

Hence, the overall percentage improvement for scenario1 optimization through all periods can be easily computed.

The general average queue length has decreased by **11.3%**, while the general average waiting time has reduced by **17.5%**.

## 8.7 CONCLUSIONS AND RECOMMENDATIONS

Optimization runs were performed for the actual simulation model of the traffic system, over the entire day, in order to try to minimize the time that a vehicle spends in the traffic system. However, the optimizer was unable to reach an optimum set of decision variables and signal light timings that met all the capacity constraints. This indicates the corruption of the pre-timed system currently applied. There is no one set of timings that can be assigned to the traffic system under study, that will be able to ignore the variability of the vehicle demands through the different periods of a day.

This led to the idea of optimizing the actual model, for every period separately, in hopes of creating a correct pre-timed system that can be applied to the roads of Alexandria. The timings will still be fixed during each period, however different pre-determined signal timings will be given to each period, in order to try and counteract the vehicle demand variability. Feasible solutions were in fact reached for all NON PEAK time periods, however the optimizer was unable to reach timings that would highly improve the system during the PEAK time periods. It is deduced that again, during those periods the arrival rates are at the highest, so it is difficult to meet certain queue lengths.

Despite good reductions made to the average queue lengths, waiting times and time in system in some periods, there were major increases in those values for other periods. It is very difficult to make comparisons using the optimized actual models, since some periods did not have a feasible solution.

After continuous thought as to solve this problem, the proposed solution, Scenario 1, is optimized. Since this scenario, discussed in depth in chapter VI, helped solve some major problems observed in the actual model, it is appropriate to optimize it.

Runs were performed for both the entire day and for the different individual periods. Again, there was no feasible solution to improve the performance through the course of the day with one set of traffic light signals. However, this time great results were achieved when optimizing the single periods. The optimizer was able to reach good solutions for all periods. Major reductions were made to parameters such as the average waiting times, queue lengths and vehicle time in system, for all periods except period 5.

Despite the fact that period five did not offer any improvement, the increase in the parameters compared to the actual system did not show a significant difference and it did not violate any of the constraints entered. Therefore, it is still considered valid.

### **Recommendations**

It is highly recommended according to the results of this chapter, that the proposed solution should be applied to the traffic system under study. Such a modification is very simple, and is achieved by adding an extra control point, and traffic signal light at control point 4, to facilitate the flow of the vehicles turning left from Shatby to Abo Eir.

In addition, the pre-timed system must be applied correctly, as this is the first step to moving towards an adaptive traffic system. Instead of having one set of signal timings, that do not consider the difference of the vehicle demands during the morning rush hour and the midnight hours, pre-determined signal timings should be applied for each period that the day is categorized in. Those timings have already been determined from the optimizations experiments performed on proposed solution model.

## **9 HARDWARE IN TRAFFIC CONTROL**

### **9.1 INTRODUCTION TO HARDWARE IN TRAFFIC CONTROL**

Hardware in traffic control is a crucial factor for the success of any traffic control strategy. Technological advancements are constantly being made in traffic control devices. These advancements are always pushing the traffic system into a smarter and more automated environment.

Traffic control devices are one of the major elements of a successful traffic control plan. In order to address a traffic control problem, the engineer or analyst should possess a background about the common technologies and modern hardware components used in traffic systems.

The rapid advancements in hardware components, sensing technologies and microcontrollers have paved the way to traffic engineers and traffic analysts to implement what they have been dreaming of for decades; an “intelligent” traffic system that allows a free smooth flow of vehicles with ideal waiting times and regularly dissipating queues across the signalized intersections of the highly populated cities. Hardware technology has two main applications in traffic engineering.

The first application is the use of sensing devices and traffic counters in detecting the traffic flow volumes crossing a certain control point at a given intersection. The complexity of such hardware varies from simple hand counters and stopwatches used in manual data counting to highly modern sensors such as inductive loops and video image processing detectors.

The second major application of hardware technologies is the implementation of an intelligent traffic control system. The demand pattern is determined, either by modern sensors or by historical information. Then, this pattern is transmitted as a signal to a controller unit, which translates this signal into correspondent traffic light timings, delivered to the signal lights at each control point.

## 9.2 TRAFFIC CONTROL SENSORS

### 9.2.1 Modern sensors

Modern “intelligent” sensors are used to count traffic flow, measure speed, measure travel time and other parameters for both the pre-timed and the adaptive traffic control systems. However, these technologies are usually more important to the adaptive traffic control systems since they provide the traffic signal controllers with instant input data in order to adjust the traffic light settings automatically. Examples of such equipment include:

**Pneumatic road tubes:** This is a special tube, which has a defined pressure. The pressure changes when a vehicle passes over it, sending a pulse to another connected recording device (counter). The major problem of a road tube is that it counts the number of axles passing over it, not the number of vehicles. Therefore, the overall count must be divided by the average number of axles per vehicle, which is obtained by sample measuring. This results in inaccurate data collection and affects the reliability of the data collected.

**Inductive loop sensor:** This type of sensors is commonly used in traffic control. A loop detector consists of one or more loops of wire embedded in the road and connected to a control box. The loop senses the presence of any metallic object passing over through the change in its inductance, sending a signal to the box to count the pass of a vehicle. The equipment is not expensive but requires professional installation as the loops are installed under the road, and must be re-installed every time the road is repaved. This type of detectors is widely used in United States is a representation of an inductive loop sensor.

**Ultrasonic detectors:** This type of sensors, shown is widely used in Japan. They operate by transmitting ultrasonic energy, and measure the energy reflected by the target. These measurements are translated to give indications of vehicle presence. These detectors are very accurate. However, their installation is difficult as it requires sophisticated position adjustments so that the ultrasonic waves accurately hit the vehicles crossing the roads.

**Magnetic detectors:** The passage of a metallic object (vehicle) interrupts the magnetic field, which generates a pulse to a connected recorder. The magnetic detectors are not vastly used in traffic engineering due to practical reasons.

**Microwave radar detectors:** Radar detectors use microwave sensors mounted over the travel lane. Energy is sent from the radar unit to the traffic lane and the reflected energy is measured by a sensor. A defined change in the reflected energy indicates the presence of a vehicle.

**Video image processing technologies VIP:** A video camera captures the traffic flow and a processor translates images into traffic counts.

### **9.2.2 Selection Criteria: The appropriate methodology/ traffic hardware**

The use of modern sensors returns much more accurate data than the manual collection technique. But this does not mean that it is always the most suitable solution for traffic data collection. An analyst or a traffic engineer must select the right tool and the right methodology for the proposed task. Therefore, careful decision-making must be carried out to select the suitable data collection methodology. Several factors should be considered by the decision maker to select the appropriate data collection methodology, and the correspondent hardware devices used. Examples of these factors are:

- **The nature of the study:** The nature of the study determines the level of accuracy and reliability of data required.
- **The flow parameters required for the study:** This is an important factor in the selection of the appropriate sensor because some sensing devices are mainly capable of measuring certain parameters that other devices cannot measure.
- **The total cost of equipment:** This includes the cost of purchasing and installing the hardware devices.
- **The feasibility:** Most sensors require professional installation, others affect the infrastructure of the road network (the roads should be repaved). In addition, the installation often requires time and massively disrupts traffic flow at congested intersections.

- **Security issues:** These expensive devices are subject to theft or damage.
- **Awareness:** The drivers' and the traffic officers' awareness and response to such technologies.
- **The weather:** The weather of the surrounding environment is a critical measure because some sensing devices do not perform effectively under bad weather conditions.

### **9.3 TRAFFIC CONTROL USING FPGA'S:**

FPGA's are Integrated Circuits consisting of an array of elements; interconnection between these elements is user-programmable. These boards represent the latest advancement in the world of automation and control. They are even advantageous compared to microcontrollers in terms of number of IO (input & output) ports and performance.

In the subsequent chapters, the possibility of applying FPGA's to control traffic systems is going to be studied in order to create a more intelligent traffic environment.



## **10 FPGA CONTROL IN A PRE-TIMED SYSTEM**

### **10.1 INTRODUCTION**

FPGA control is a booming trend in the world of modern control and automation. FPGA's are widely used in a variety of applications for the purpose of system control and operation. This chapter discusses the possibility of implementing an FPGA design to a pre-timed traffic control system in order to control the traffic operations automatically.

However, to pursue with the content of this chapter, a quick review on the different types of traffic control systems should be presented. There exist three different types of traffic control systems employed word widely:

- **Chaotic traffic system:** This system is the most primitive traffic control system. It is only found in developing countries which still find some difficulties in implementing a reliable traffic control strategy. In the chaotic traffic system, signal timings are fixed throughout the different periods of the day, which does not correspond to the fluctuating demand pattern. In addition, the timings are pre-set based on the experience and rough estimation of the officer in charge which is highly subjected to error and inaccuracy
- **Pre-timed traffic control system:** In this system, the signal timings are evaluated using accurate experiments and studies based on historical data. The timings are pre-set and fixed throughout a specified period interval. Timings change from one period to another according to the correspondent demand pattern obtained by data collection and measurements.
- **Adaptive traffic control system:** This system represents the latest advancement in the traffic control field. It is only found in developed countries which had previously upgraded their pre-timed control systems. In this type of system, the signal timings change instantaneously based on the instantaneous change in demand pattern detected by installed field sensors.

This chapter is concerned with the application of FPGA's in order to automatically control a pre-timed traffic control system.

## 10.2 THE PRE-TIMED TRAFFIC CONTROL SYSTEM: THEORY OF OPERATION

The concept of utilizing FPGA control for traffic applications is quite simple. During previous chapters, several experiments and scenarios have been carried out to optimize the traffic signal timings for the intersection under study. These optimized state timings will be utilized in the FPGA program design.

The FPGA design is carried out to control a pre-timed traffic control system in a simple two way intersection. The geometrical layout of the intersection is illustrated in Figure 10-1:

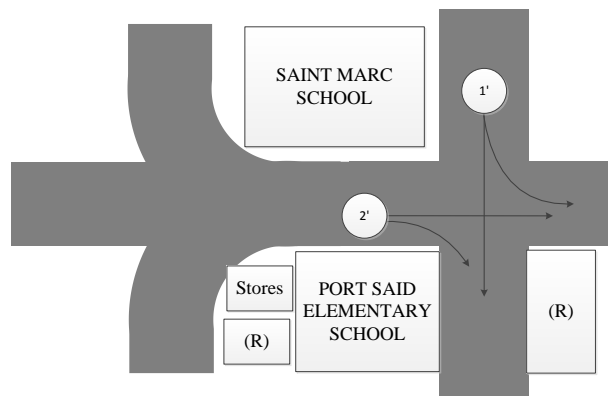

Figure 10-1: intersection (1) layout where the FPGA control will take place

The phase plan of the intersection is entered to the design as input. Table 10-1 illustrates the phase plan of the intersection under study:

**Table 10-1: phase plan of intersection under study in FPGA control**

State	Control Point		State timing (sec)
	1'	2'	
A'	R	G	$T_A$
B'	G	R	$T_B$

### 10.3 THE HARDWARE DESIGN OF THE PRE-TIMED TRAFFIC CONTROL SYSTEM

The design of a hardware controller onto the FPGA can be pursued in two different ways, either in schematic or in textual fashion. In both ways the Xilinx Integrated Software Environment (ISE) is used. The ISE is a software environment developed specifically for Xilinx FPGA chips, which are the type of programmable chips that we have bought for this project; NEXYS-2 Xilinx Spartan-3E FPGA board by DIGILENT Inc..

The schematic design utilizes logic gates found in the ISE's library. The textual design is accomplished by writing code using the VHDL programming language that describes the behavior of the controller. The code is then synthesized into FPGA's primitive hardware elements using the synthesizer that is part of the ISE.

In this project, we follow the second design methodology; VHDL programming, since it is versatile and flexible to changes. The hardware design is first described in terms of finite state machines and algorithmic state machines, which is an analog to the flowcharts in software design. We then write a VHDL code that represents the behavior of these state machines.

The first state machine describing the outer behavior of the hardware controller is given in Figure 10-2.

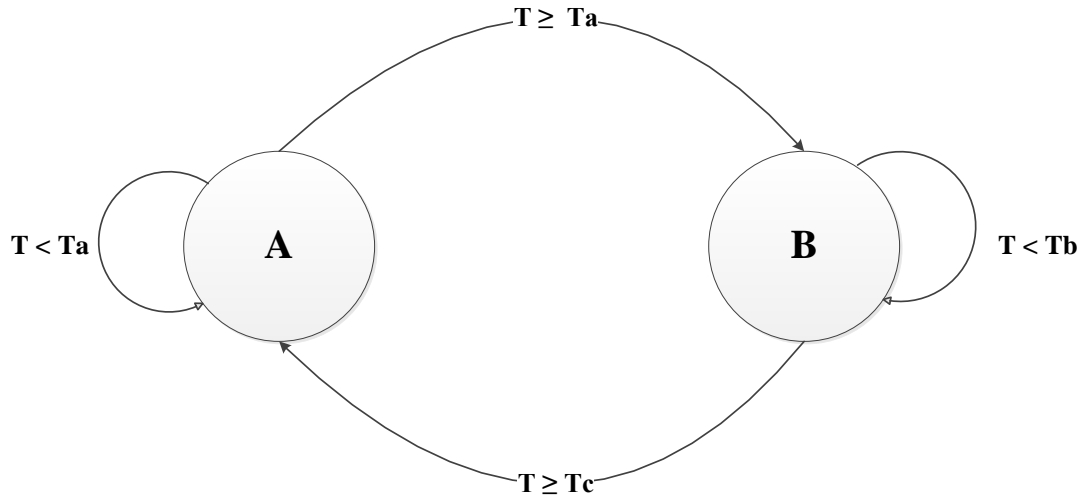

**Figure 10-2: state diagram of the intersection under study in FPGA control**

Where,

- A : State (A) in the intersection under study*
- B : State (B) in the intersection under study*
- $T_A$  : optimized state timing (A)*
- $T_B$  : optimized state timing (B)*

In the previous figure, there are two main states in which the system exists alternatively. In state A, the controller gives a red signal to the traffic in point 1 and a green signal to the traffic point 2. State A is kept for a certain time, namely  $T_a$ . The hardware controller then moves the system into state B in which the traffic point 1 is given the green signal this time and the traffic point 2 is given the red signal for a finite  $T_b$  time.

The inner behavior of the hardware controller is given in the Algorithmic State Machine (ASM) shown in Figures 10-3 and 10-4.

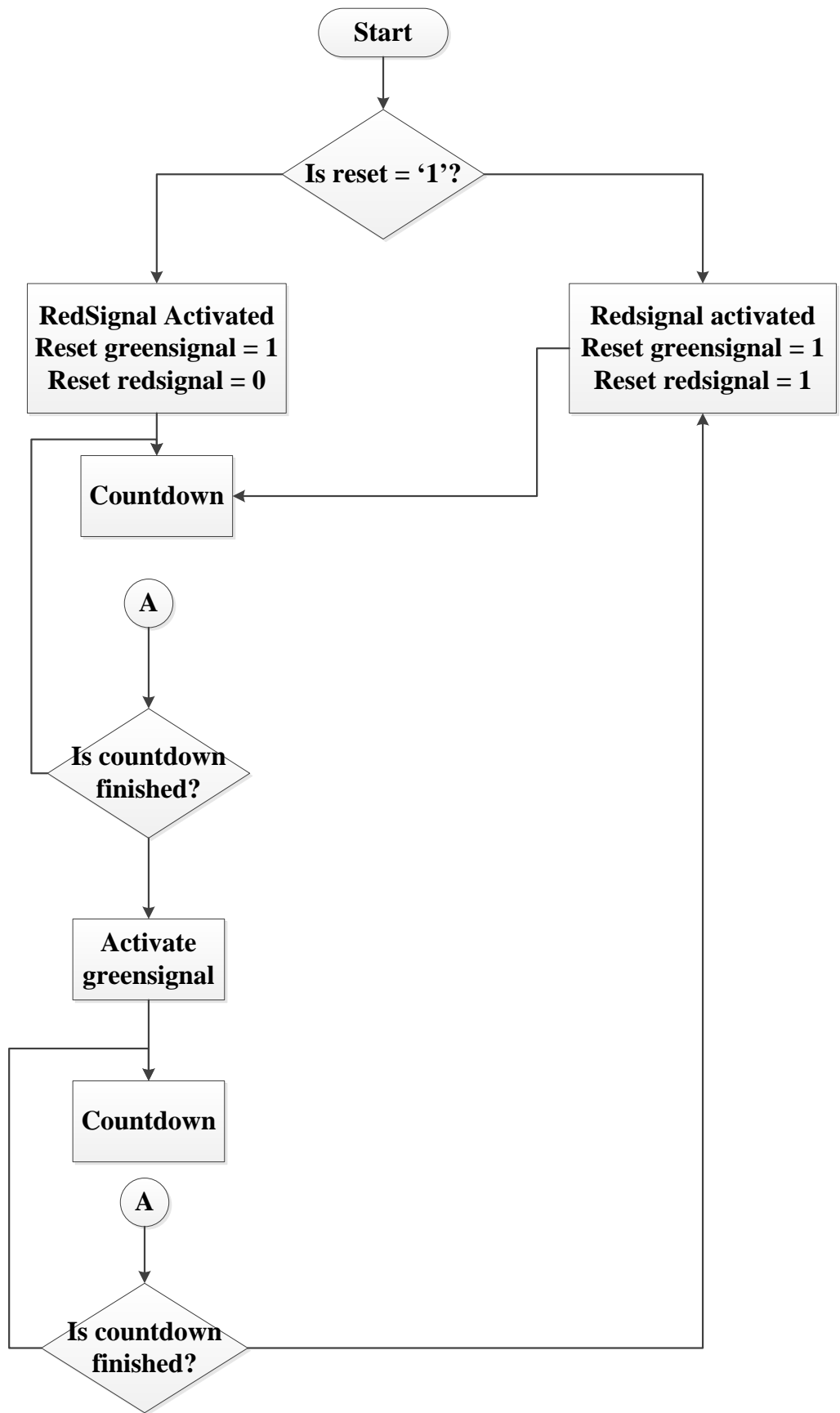
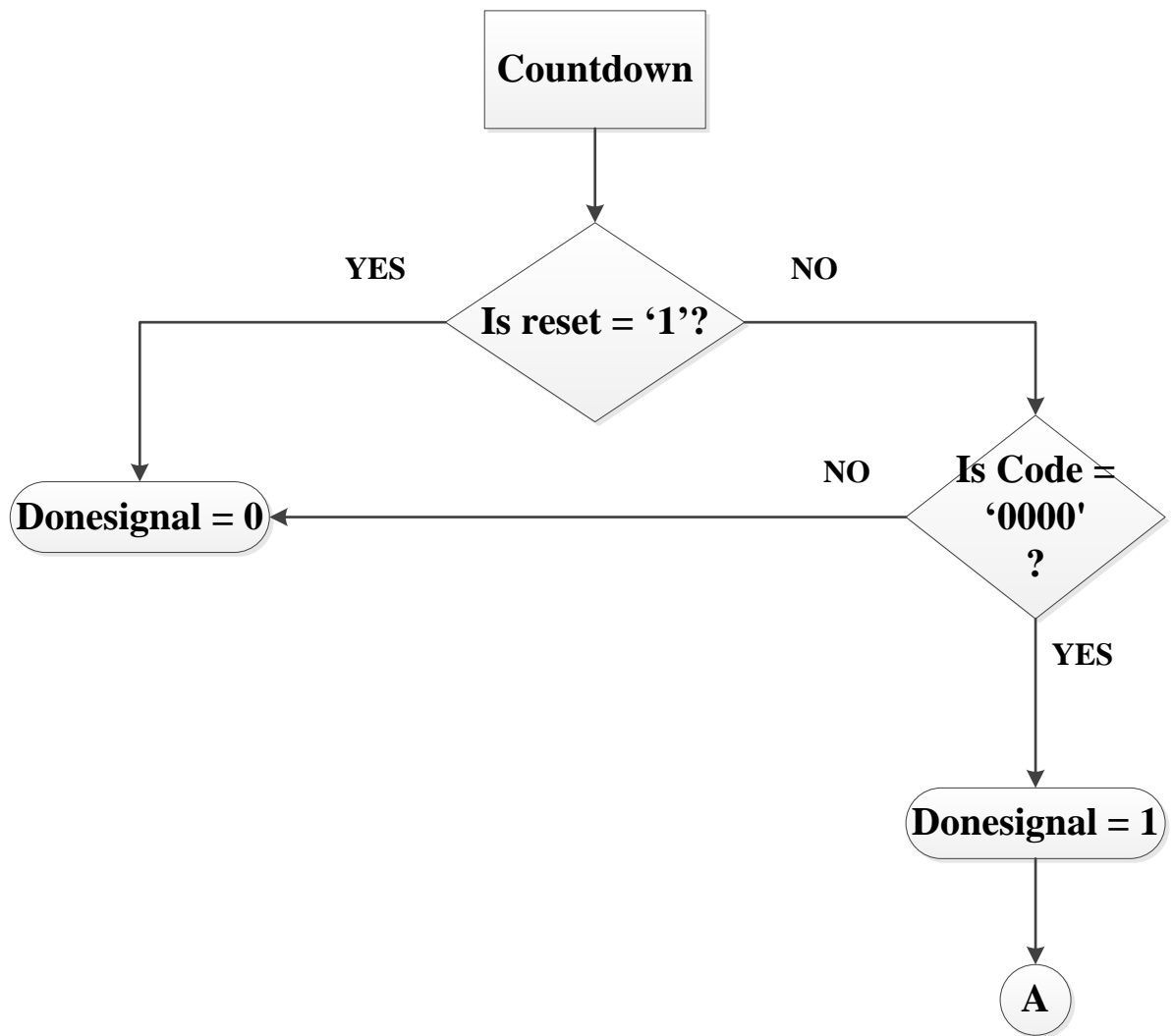

Figure 10-3: ASM of FPGA design to control a pre-timed system



**Figure 10-4: Countdown procedure in an FPGA design to control a pre-timed system**

The VHDL program that describes the above ASM should consist of a set of nested if conditions, together with a counter used to carry out the countdown process of the traffic signal. The hardware controller constantly compares the optimized traffic signal timings, which is hardwired into the design, with the current counter timing and decides whether to stay in the current state or to pass onto the next state.

The design defines a set of signals to be used throughout the coding. However, two signals are the most critical to the operation of the design. These are redsignal (R1) and greensignal (G1). R1 signifies the red signalization state for control point 1 in the intersection in study, while G1 represents the green signalization to control point 1. R1, being the red signal for control point1, is definitely being a green signal for the opposite

control point 2, as the intersection on which the design is implemented is a simple two-way intersection.

**Table 10-2: design signals correspondent to signal timings in FPGA design**

Control Point	Signalization		State timing	Design signal
1	R	G	$T_A$	“R1”
2	G	R	$T_B$	“G1”

These two signals have a value of either “0” or “1” depending on the logical structure of the coding.

Two other signals, which are not less important than the first two, are also defined in the design. These are “resetsignalgreen” and “resetsignalred”. They indicate the initialization of the state timings.

The major procedure in the design is the timing control process, where the state transition takes place. It consists of a set of nested if conditions that describe the logical sequence of the state machine illustrated above.

The “if then else” conditions start with checking the reset button. The reset button is an input button assigned on the FPGA to manually reset the two signals whenever desired. If reset button is pushed, both signal timings are initialized through pulsing ones to both the reset signals. Then, the program is designed to activate the redsignal “R1” as default. Countdown of R1 starts, with the entered value of the previously optimized state timing. Countdown is another procedure, which counts down the signal timings. Whenever the countdown is ended, a signal called “donesignal” is pulsed.

Once R1 is activated and the countdown starts, state R1 is the dominant state, while the green state timing is still fixed and not shown on the display. As soon as the countdown process ends, the state transition takes place, G1 signal dominates, and the countdown is now assigned to the green signal. At last, when the green state timing tends to zero, after

the countdown process, both signals are reset, the red signal R1 is activated once again, marking the start of a new cycle.

The state timings' countdown is displayed as output signals on 7-segments for visualization. In real world application, the signal light displays will replace the 7-segments.

## **10.4 FPGA SYNTHESIS AND IMPLEMENTATION**

The design has been written out in VHDL language in the Xilinx ISE environment. The Xilinx XST tool has synthesized the design into hardware components as shown in figure 10-5.



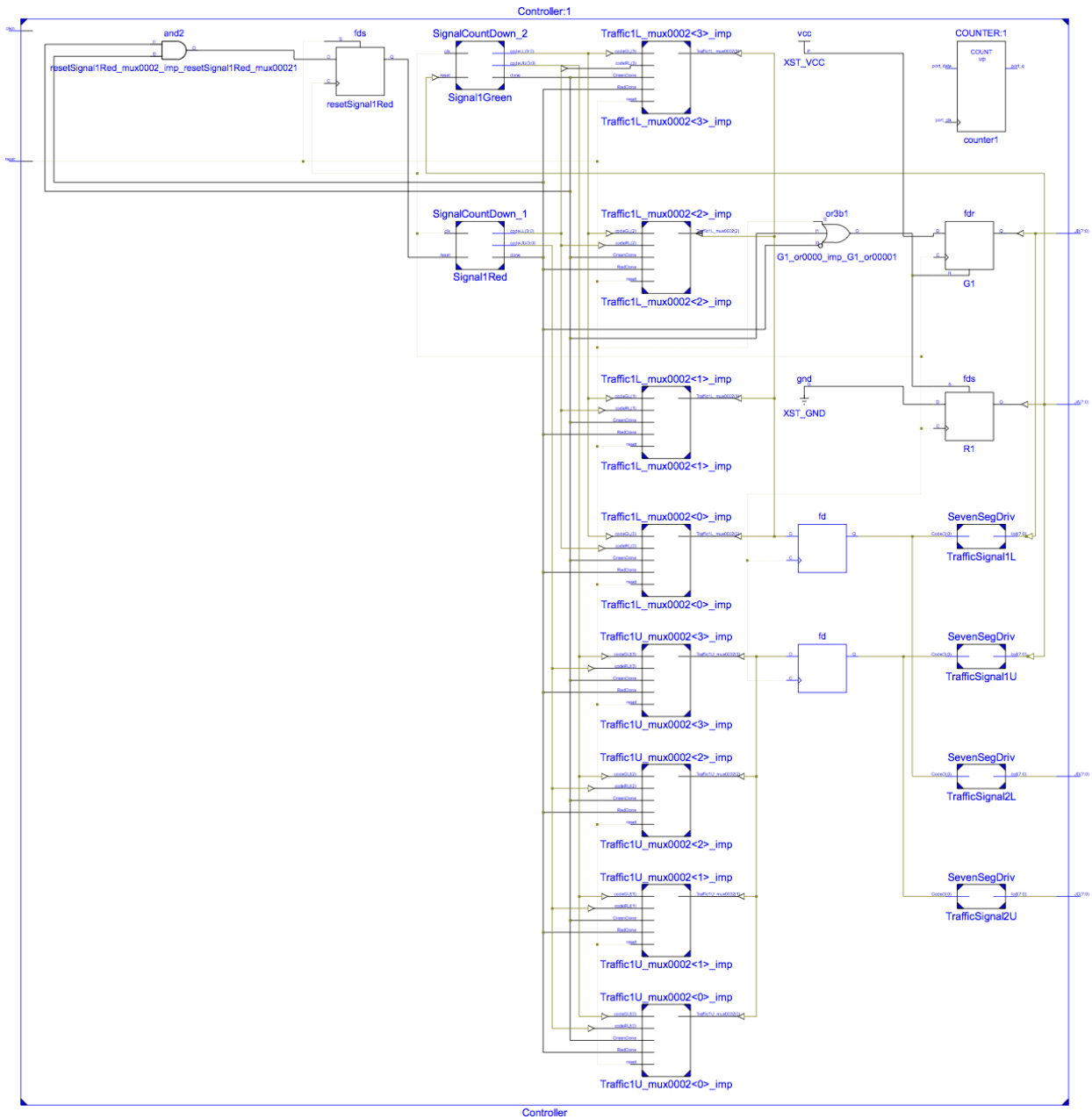

**Figure 10-5: Design Synthesis**

The synthesized design is then placed and routed using the Xilinx Place & Route tool. A screen snapshot of the design placed on the FPGA is given in figure 10-6.

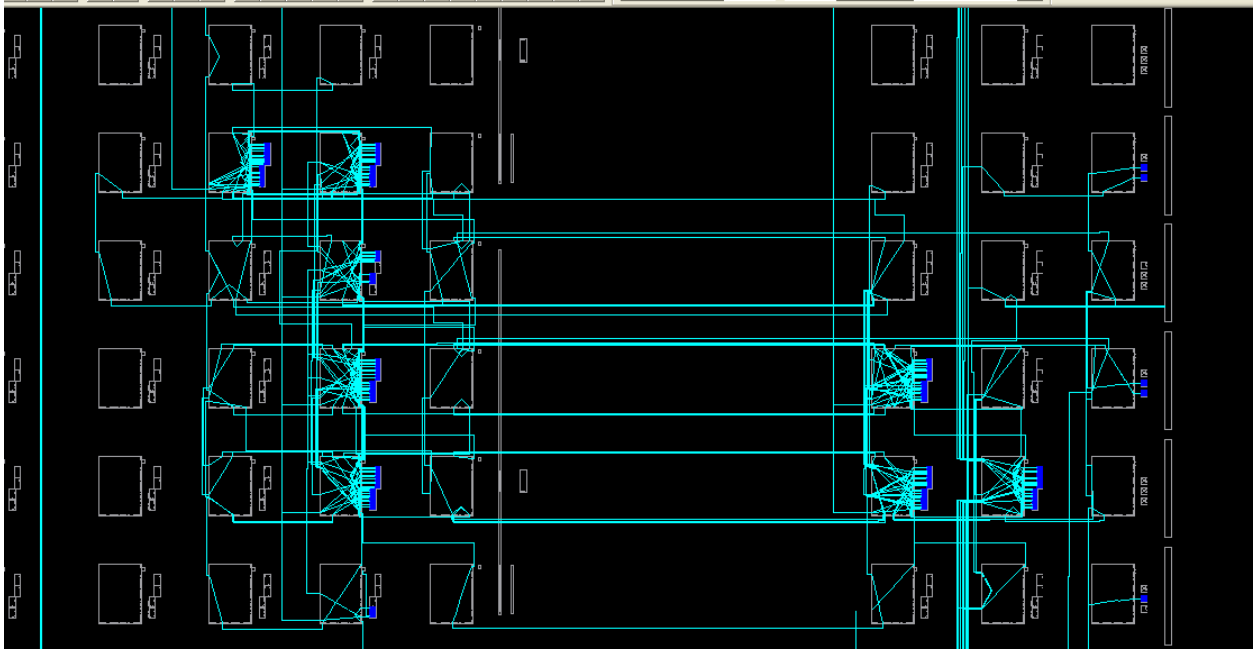

**Figure 10-6: Routing and placing**

## 10.5 PROTOTYPING

Now that the FPGA design is successfully running, it is strongly recommended to model the work on a physical prototype to ensure the reliability of the program design, and visualize the work done.

The prototype consisted of two opposite wooden plates representing the main two vehicular streams. Adequate landscape, road layout, aesthetic features are carefully design to physically approach the reality. Each wooden plate is driven by a DC motor. Once the prototype is accurately installed, the program is started. The FPGA implements the logical pre-designed sequence.

As “R1” is activated, two signals are generated. One signal is sent to the DC Motor 2 “M2” connected to the correspondent control point (CP2). The motor catches the signal; motion is generated and transmitted to the wooden plate representing the control point having the green signalization. The motion of the wooden plate, with vehicles attached on its interface, represents the dissipation of vehicular flow in CP (2) and the queuing process in CP (1). The other signal is sent to the 7 segment which display the correspondent pre-optimized state timing.

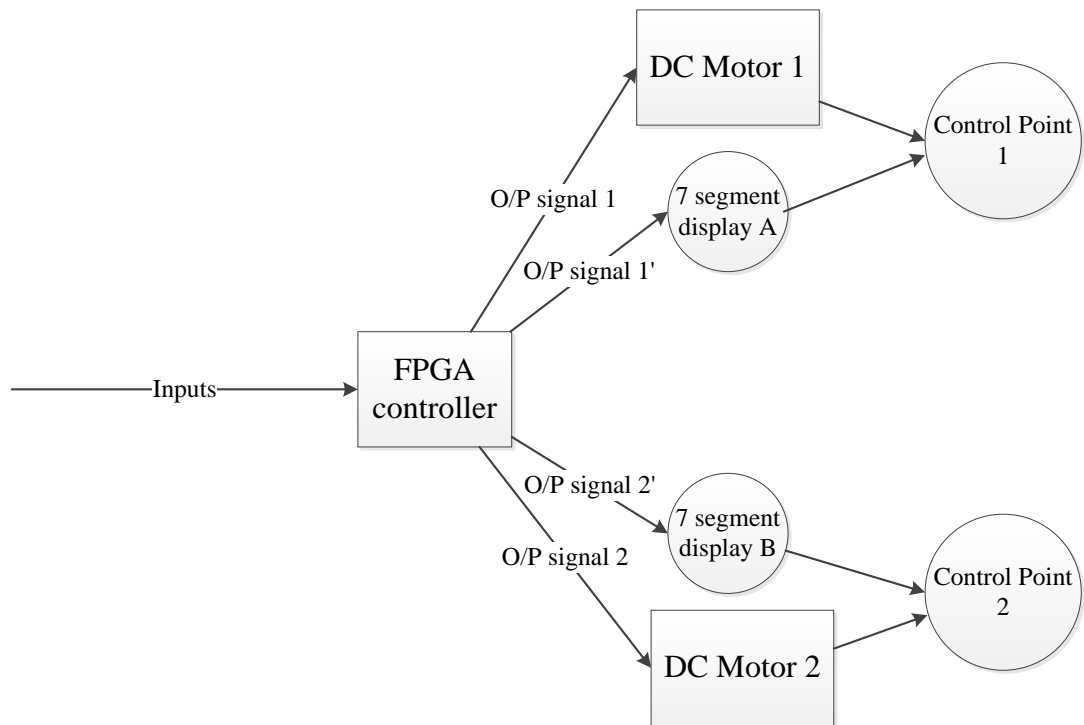

**Figure 10-7: Theory of operation of the prototype of FPGA controlling a traffic system**

As soon as the countdown finishes, the FPGA design is followed to carry out the state transition process. Similar signals are sent to DC Motor 1 and the correspondent 7-segment to represent the opposite state. And hence, the cycle is pursued representing a simplified prototype of a pre-timed traffic control system fully controlled by FPGA's.



**Figure 10-8: The prototype representing FPGA control in a pre-timed traffic control system**

## **10.6 CONCLUSIONS**

Through experimentation, FPGA control, a modern trend in the world of control and automation, has proven its reliability and success in the field of traffic control. Based on the experimentation results attained in this chapter, FPGA's can be successfully implemented to control the operation of a pre-timed traffic control system. It ensures the complete automation of the system, without the need of any human interference.

## **11 FPGA CONTROL IN AN ADAPTIVE TRAFFIC SYSTEM**

### **11.1 INTRODUCTION TO FPGA'S**

Short for **Field-Programmable Gate Array**, a type of logic chip that can be programmed. Field Programmable refers that the FPGA's function is defined by a user's program rather than by the manufacturer of the device.

The main difference between FPGA's and IC's is that a typical integrated circuit performs a particular function defined at the time of manufacture. In contrast, the FPGA's function is defined by a program written by someone other than the device manufacturer. This user programmability gives the user access to complex integrated designs without the high engineering costs associated with application specific integrated circuits.

#### **Top 5 Benefits of FPGA Technology**

- Performance
- User programmability
- Cost
- Operation

**Performance:** FPGA's highly exceed the traditional performance of controllers and processors.

**User programmability:** The FPGA design can be altered at any time to reflect desired changes in the model.

**Cost:** FPGA's are not relatively expensive compared to the sophisticated devices used in traffic control in most developed countries.

**Operation:** FPGA's are user friendly, they are easy to design and program. In addition, once programmed, they can easily operate the traffic control network without interruption or breakdowns.

## **11.2 THE DESIGN OF A FPGA-BASED ADAPTIVE TRAFFIC CONTROL SYSTEM: THEORY OF OPERATION**

In the previous chapter, FPGA control has proven its efficiency as a reliable strategy to control the operation of a pre-timed traffic control systems.

This section of the report throws up a question to whether FPGA control can be used to control an adaptive traffic control system.

Adaptive traffic control systems are quite different than pre-timed systems. In these systems, signal timings change constantly from one cycle to another based on the current state of the intersection. This state is often determined using modern sensing devices.

Achieving an FPGA design for that type of system is thought to be a complex operation. However, the concept of the design can easily be understood.

Most modern FPGA's have input ports for surveillance cameras and other counting devices. If these devices can be –by any means- connected to the sensing devices that determine the current system state, FPGA's could certainly sense the traffic environment.

An FPGA program design can be developed to process this signal into timings. This can be done through a simple equation which calculates the timings necessary to dissipate a given queue length based on the dissipation rates characterizing each control point.

Finally the FPGA should be directly connected to the traffic lights for the output numbers to be shown on the control points' displays.

### **11.3 FPGA'S: ADVANTAGES VS. LIMITATIONS**

FPGA design tools are increasingly available, allowing control system designers to more quickly create and adapt FPGA hardware. It is expected in the future, that FPGA's will replace the traditional controllers in most systems.

However, there exist some limitations to the use of FPGA's in traffic control systems:

- Completely automating the traffic environment will increase the installation and maintenance costs compared to traditional traffic control systems.
- Increasing the amount of hardware devices in a system, will definitely increase the chances of failures. Therefore, adequate maintenance plan should be carried out to overcome this problem and preserve the reliability of the system.
- FPGA's should be placed in a well-protected control unit for the purpose of protection from climate changes, theft or any damage. High protection should be provided because a single error in the FPGA structure will definitely lead to the failure of the control system and the dominance of chaos in the surrounding environment.

### **11.4 CONCLUSIONS**

The modern ways of traffic management improves the traffic condition up to a large extent. Advanced signalling controllers contribute to the improvement of the urban traffic. FPGA control is a proposed control strategy to automate the traffic control environment and hence, lead to a better system performance.

## **12 CONCLUSIONS AND RECOMMENDATIONS**

This project has shed light on one of the vital problems that threaten the splendour of the beautiful city of Alexandria, and the livelihood of its citizens. The problem of traffic congestion has become a heavy burden on the shoulders of both the governments and the peoples. The absence of a reliable control strategy that regulates the traffic control operation is one of the main motives of this problem. Throughout the course of this report, various techniques and approaches have been suggested to overcome the traffic congestion dilemma and cut off the problem from its root causes.

Through careful field observation and problem monitoring, data about the system variables, parameters and metrics through different periods of the day, has been collected in order to define the underlying aspects of the problem. Adequate statistical analysis has been carried out for data treatment, fitting and analysis. This has been a crucial phase of the project, as the accuracy of the collected data has been the strong base which held all the work done together.

In addition, an analytical model formulation has been developed to accurately represent the system. The model clearly defines the decision and response variables, the system parameters, the proposed objective function(s) and the governing constraints. Several solution approaches have been proposed to solve the formulated model.

**Genetic Algorithm**, a computational approach inspired by the evolution theory, and a revolution in the world of meta-heuristic techniques, is a powerful optimization tool that shows itself as a reliable solution. A successful Genetic Algorithm experiment has been conducted for the purpose of optimizing traffic signal timings in two consecutive intersections in Alexandria's road network. The G.A. optimized signal timings have been entered to a developed simulation model to emulate the consequences that might take place. Promising results have been obtained, indicating great improvements in the performance of the system. Compared to the actual system performance, general average queue length has reduced by **43 %**, while the general average vehicular waiting time showed a similar decrease of **30.2 %**.



Turning to a completely new approach to handle the problem, **simulation** has been suggested as a reliable solution. Extendsim8, a powerful simulation package has been successfully utilized to develop a simulation model that accurately replicates the system under study. The actual performance of the current situation, under the current circumstances, has been simulated. It has been demonstrated that the current state of the system exhibits relatively weak performance, due to the extreme values of queue lengths and vehicular waiting times that have been detected. Moreover, simulation has been utilized to develop better scenarios for the system. Scenario1, a proposed simulation model for the system, through making a major change in the road network's phase plan and operational logic, has been suggested and proven to exhibit remarkable improvement in terms of performance metrics. General average queue length has decreased by **4 %**, while the average vehicular waiting time has been reduced by **29.6 %**.

In addition, **Optimization using simulation** has arisen as one of the main solution techniques of this project. Using Extendsim8 optimizer, the set of signal timings controlling the road network under study has been optimized and simulated. Favorable results have been attained, signifying the success of the optimization experiments. The general average queue length has decreased by **11.3 %**, while the general vehicular waiting time has reduced by **17%**.

All The previous proposed solutions have been planned to analyze and control the performance of a pre-timed traffic control system. Adaptive, also called smart or actuated, traffic control systems represent the most advance phase of traffic strategies. ATCSs' adapt their signal timings instantaneously according to the current demand pattern. A simulation model has been developed to study the possibility of applying an **adaptive traffic control system** to a simple two way intersection in Alexandria, Egypt. The results showed the greatest improvement, as ATCS's are well-known in the developed countries of their superiority over the traditional pre-timed systems. General queue length has decreased by **74%**, whereas vehicular waiting time has been reduced by **69.2 %**.

Holding comparisons between different proposed solutions, along with the actual performance is one of the major conclusions of this project. Charts shown in Figures

12-1, 12-2, 12-3 and 12-4 visualize these comparisons and help the decision makers in deciding which strategy to implement.

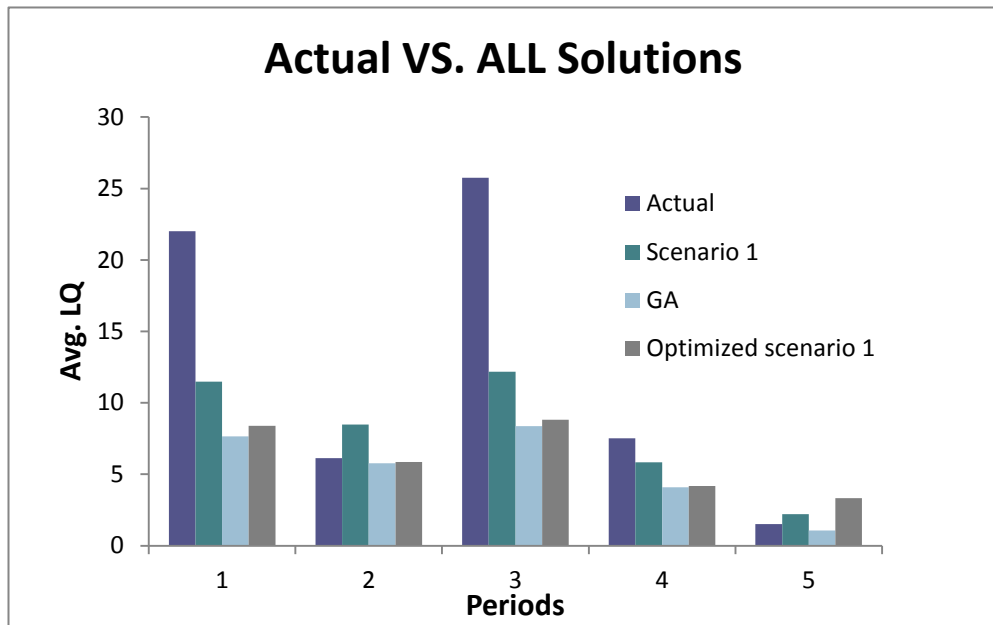

Figure 12-1: Actual system vs. all the proposed solutions in terms of LQav

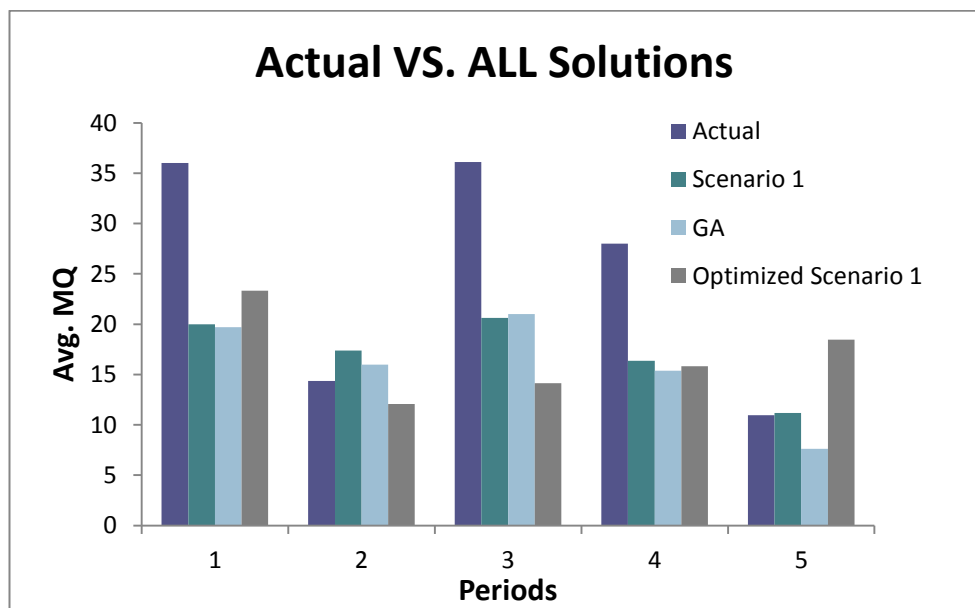

Figure 12-2: Actual system vs. all the proposed solutions in terms of WQav

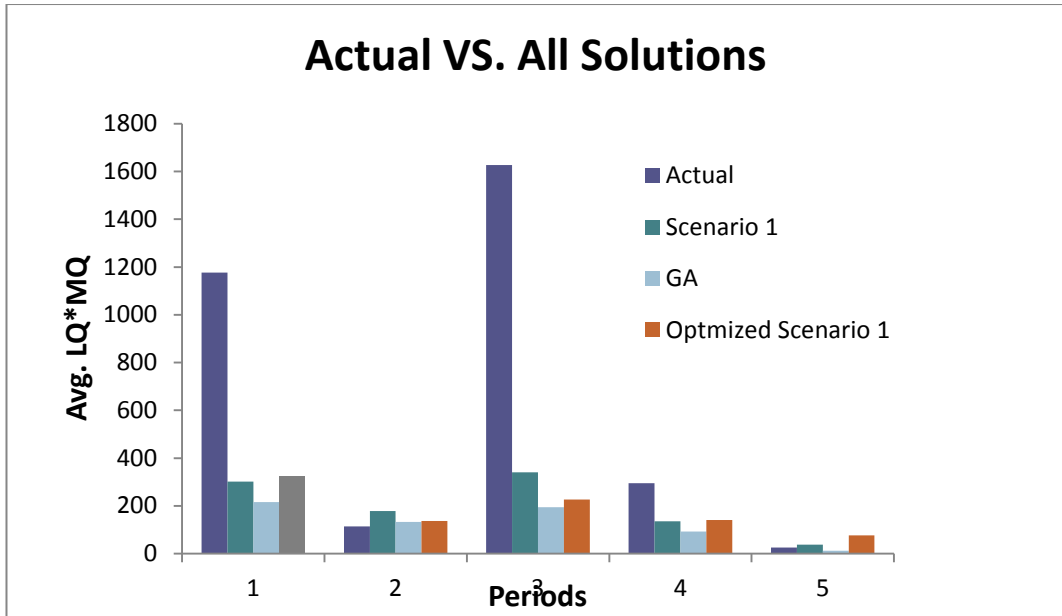

Figure 12-3: Actual vs. all proposed solutions in terms of  $(LQ_{av} * WQ_{av})$

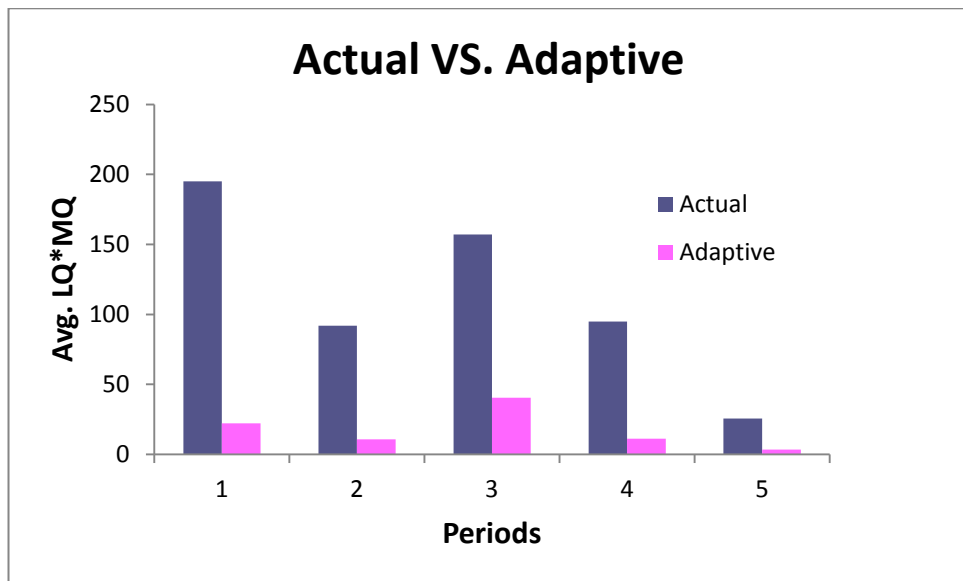

Figure 12-4: Actual system vs. adaptive model in terms of  $(LQ_{av} * WQ_{av})$

The last part of the report has covered a deep introduction to the technological advancements in the hardware used in traffic control. **Traffic control using FPGA's**, the latest trend in the world of automation and control, has appeared to be a reliable control strategy. The possibility of applying FPGA control to a pre-timed traffic control system has been studied, and proven to be successfully operating. The optimized timings have been entered in the FPGA design, which achieves the automatic state transition and control over the road network. This is expected to be a large step forward

towards the automation of traffic control systems, minimizing human interference as much as possible.

### **Recommendations**

The greatest evaluation challenge for this project is to be implemented on the real-world system. It would be interesting to experiment the attained results on the steady ground of reality and assess the consequences that may take place.

It is also remarkable that, unless both the government and the citizens cooperate through awareness and efforts, tangible improvements to the traffic environment can hardly be created.

In case of the success of the implementation phase, the study could be generalized to other major intersections in Alexandria's road network to cut off one of the major problems that threatens the stability and the splendour of this beautiful city.

## REFERENCES

- [1] R. P. Roess, E. S. Prassas, and W. R. McShane, *Traffic Engineering*: Pearson, 2011.
- [2] L. Vas, "Mathematical Modeling - Introduction and early examples."
- [3] "Introduction to Analytical problem solving."
- [4] G. V. Caliri, "Introduction to Analytical Modeling," U.S.A.
- [5] T. V. Mathew, "Genetic Algorithm," Indian institute of technology, Bombay, India.
- [6] E. K. Prebys, "The Genetic Algorithm in Computer Science," *MIT Undergraduate Journal of Mathematics*, pp. 165-170.
- [7] P. Reed, B. Minsker, and D. E. Goldberg, "Design a competent simple genetic algorithm for search and optimization," 2000.
- [8] R. P. Roess, E. S. Prassas, and W. R. McShane, *Traffic Engineering*, Fourth edition ed.: Pearson.
- [9] K. Saharia, "Traffic Optimization System: Using a Heuristic Algorithm to Optimize Traffic Flow and Reduce Net Energy Consumption," Monta Vista High School USA.
- [10] J.-Q. Li, G. Wub, and N. Zou, "Investigation of the impacts of signal timing on vehicle emissions at an isolated intersection," *Transportation Research Part D 16 (2011) 409–414*, vol. 16, pp. 409–414, 2011.
- [11] X. Li, G. Li, S.-S. Pang, X. Yang, and J. Tian, "Signal timing of intersections using integrated optimization of traffic quality, emissions and fuel consumption: a note," *Transportation Research Part D* vol. 9, pp. 401-407, 2004.
- [12] M. Dotoli, M. P. Fanti, and C. Meloni, "A signal timing plan formulation for urban traffic control," *Control Engineering Practice* vol. 14, pp. 1297–1311, 2006.
- [13] A. Azadeh and A. Sadeghnia, "Design and Optimization of a Traffic Control System by Integration of Computer Simulation and Genetic Algorithm," *Australian Journal of Basic and Applied Sciences*, vol. 3, pp. 4333-4343, 2009.
- [14] T. Kalganova, G. Russell, and A. Cumming, "Multiple Traffic Signal Control Using A Genetic Algorithm," presented at the Fourth International conference on artificial neural networks and genetic algorithms, Portoroz, Slovenia, 1999.
- [15] L. Singh, S. Tripathi, and H. Arora, "Time Optimization for Traffic Signal Control Using Genetic Algorithm," *International Journal of Recent Trends in Engineering*, vol. 2, pp. 4-6, 2009.
- [16] L. Zang, P. Hu, and W. Zhu, "Study on Dynamic Coordinated Control of Traffic Signals for Oversaturated Arterials " *Journal of Information & Computational Science* vol. 9, pp. 3625–3632, 2012.
- [17] Y. K. Chin, K. C. Yong, N. Bolong, S. S. Yang, and K. T. K. Teo, "Multiple Intersections Traffic Signal Timing Optimization with Genetic Algorithm," presented at the International Conference on Control System, Computing and Engineering, 2011.

- [18] J. He and Z. Hou, "Ant colony algorithm for traffic signal timing optimization" *Advances in Engineering Software* vol. 43, pp. 14-18, 2012.
- [19] R. Putha, L. Quadrifoglio, and E. Zechman, "Comparing Ant Colony Optimization and Genetic Algorithm Approaches for Solving Traffic Signal Coordination under Oversaturation Conditions," *Computer-Aided Civil and Infrastructure Engineering* pp. 14-28, 2012.
- [20] R. G. Ingalls, "Introduction to simulation," presented at the Winter simulation conference, 2011.
- [21] A. M. Law, "How to build valid and credible simulation models " presented at the Winter simulation conference, 2009.
- [22] R. E. Shannon, "Introduction to the art and science of simulation " presented at the Winter simulation conference, 1998.
- [23] J. Banks, "Introduction to simulation," presented at the Winter simulation conference, 2000.
- [24] R. G. Ingalls, "Introduction to simulation," presented at the Winter simulation conference, 2001.
- [25] A. M. Law, "How to conduct a successful simulation study " presented at the Winter simulation conference, 2003.
- [26] J. Banks, J. S. C. II, B. L. Nelson, and D. M. Nicol, *Discrete-Event System Simulation*, Fifth Edition ed.: Prentice Hall, 2009.
- [27] A. M. Law, *Simulation Modeling and analysis*, 4th edition ed. USA: Prentice Hall, 2006.
- [28] M. Pidd, *Computer simulation in management science*, 3rd edition ed., 1992.
- [29] W. D. Kelton, R. P. Sadowski, D. T. Sturrock, W. Kelton, R. Sadowski, and D. Sturrock, *Simulation with Arena*, 4th edition ed.: McGraw-Hill Science, 2003.
- [30] L. G. Birta and G. Arbez, *Modelling and Simulation: Exploring Dynamic System Behaviour*, 2007 edition (January 24, 2011) ed., 2011.
- [31] D. C. Harrell, Dr. Biman, K. Ghosh, and D. R. O. Bowden, *Simulation using Promodel*, Second edition ed.
- [32] B. Sadoun. (2008) On the Simulation of Traffic Signals Operation 285-295.
- [33] C. M. Mwangi, S. M. Kang'ethe, and G. N. Nyakoe, "Design and simulation of a fuzzy logic traffic signal controller for a signalized intersection " presented at the JKUAT scientific technological and industrialization conference, Kenya, 2010.
- [34] R. H. Smith and D. C. Chin, "Evaluation of an Adaptive Traffic Control Technique with Underlying System Changes," presented at the Winter Simulation Conference, 1995.
- [35] J. Clark and G. Daigle, "The importance of simulation techniques in its research and analysis," presented at the Winter simulation conference, 1997.
- [36] M. STANIEK, "The cross roads lights fuzzy controller development principles in VISSIM environment," *ZESZYTY NAUKOWE POLITECHNIKI SLASKIEJ*, pp. 88-95, 2011.
- [37] A. Albagul, M. Hrairi, Wahyudi, and M. F. Hidayathullah, "Design and Development of Sensor Based Traffic Light System," *American Journal of Applied Sciences* vol. 3, pp. 1745-1749, 2006.

- [38] M. E. Fouladvand, Z. Sadjadi, and M. R. Shaebani, "Optimized traffic flow at a single intersection: traffic responsive signalization," *JOURNAL OF PHYSICS A: MATHEMATICAL AND GENERAL*, pp. 561-579, 2004.
- [39] D.-W. Huang and W.-N. Huang, "Optimization of Traffic lights at crossroads," *International Journal of Modern Physics C*, vol. 14, pp. 539-548, 2003.
- [40] S. Belbasi and M. E. Foulaadvand, "Simulation of traffic flow at a signalized Intersection," *Journal of Statistical Mechanics: Theory and Experiment*, pp. 1-15, 2008.
- [41] K. Yamada and T. N.Lam, "Simulation Analysis of two adjacent traffic signals," presented at the Winter simulation conference, 1985.
- [42] E. C. P. Chang, "How to decide the interconnection of isolated traffic signals," presented at the Winter simulation conference, 1985.
- [43] S.-B. Cools, C. Gershenson, and B. D'Hooghe, "Self-organizing traffic lights: A realistic simulation," 2006.
- [44] P. Li and M. Abbas, "Stochastic Dilemma Hazard Model at High-Speed Signalized Intersections," *Journal of transportation and engineering*, vol. 136, pp. 448-456, 2010.
- [45] K. N. Hewage and J. Y. Ruwanpura, "Optimization of traffic signal light timing using simulation," presented at the Winter simulation conference, 2004.
- [46] W. C. Howell and M. C. Fu, "Simulation Optimization of Traffic Light Signal Timings via Perturbation Analysis," 2006.
- [47] A. A.Saka, G. Anandalingham, and N. J.Garber, "Traffic signal timing at isolated intersections using simulation optimization," presented at the Winter simulation conference, 1986.
- [48] J. J.Swayn. (2009) To Boldly Go. *ORMS*. 50-53.
- [49] "Recent Modeling Enhancement to CORSIM," ed: University of Florida,Transportation Research Center and theMcTrans Center, 2012.
- [50] I. ITT Industries, Systems Division and A. R. D. a. S. E. P. Team, "CORSIM User's Guide," ed, 2006.
- [51] L. E. Owen, Y. Zhang, L. Rao, and G. McHale, "Traffic flow simulation using CORSIM," presented at the Winter Simulation Conference 2000.
- [52] B. Diamond, D. Krahl, A. Nastasi, and P. Tag, "Extendsim advanced technology: integrated simulation database," presented at the Winter simulation conference, 2010.
- [53] D. Krahl, "Extend: an interactive simulation tool," presented at the Winter simulation conference, 2003.
- [54] D. Krahl, "Extendsim 7," presented at the Winter simulation conference, 2008.
- [55] G. S. a. partners, "Traffic data collection procedures ", Kentucky, USA2002.
- [56] m. o. w. a. t. Roads department, Botswana, "Traffic data collection and analysis," 2004.
- [57] R. T.Hintersteiner, "Vehicle detectors."
- [58] D. D. Romero, A. S. Prabuwno, Taufik, and A. Hasniaty, "A review of sensing techniques for real time traffic surveillance," *Journal of applied sciences* vol. 11, pp. 192-198, 2011.

- [59] M. Gentili and P. B. Mirchandani, "Locating sensors on traffic networks: Models, challenges and research opportunities"  
" *Transportation Research Part C* vol. 24, 2012.
- [60] M. Gentili and P. B. Mirchandani, "Locating Active Sensors on Traffic Network," *Springer Science, Annals of Operations Research* vol. 136, pp. 229-257, 2005.
- [61] R. Weil, J. Wootton, and A. Gurcia-Ortiz, "Traffic incident detection: sensors and algorithms,"  
*Elsevier science Ltd, Mathl Comput. Modelling*, vol. 27, pp. 257-291, 1998.
- [62] Extendsim8 user guide



## **APPENDICES**

- Appendix (A): Genetic Algorithm coding using VBA.
- Appendix (B): Extendsim8 blocks and libraries.
- Appendix (C): Data points and observations.

## APPENDIX (A): GA CODING USING VBA

```
Dim State(5, 5)
Dim period(5)
Dim Arr_rate(6, 6)
Dim TArriv(6, 6, 10000)
Dim num_periods
Dim num_CP
Dim num_states
Dim num_arrived(6, 6)
Dim inter_delay(6, 6)
Dim CTmax(6)
Dim CTmin(6)
Dim Label(50)
Dim prop(6, 6, 50)
Dim proportion(6, 6)
Dim CT(6, 50)
Dim CTq(6)
Dim CP
Dim QLmax(6, 6, 50)
Dim QWmax(6, 6, 50)
Dim QLav(6, 6, 50)
Dim QWav(6, 6, 50)
Dim QW
Dim QL_max
Dim QL_av
Dim QW_max
Dim QW_av
Dim Gener_QL(50)
Dim Gener_QW(50)
Dim Gen_QL
Dim Gen_QW
Dim YFit(50)
Dim Tdep(6, 6, 10000)
Dim candidate(2)
Dim pop_size
Dim mut_p
Dim xover_p
Dim num_generations
```

---

```
Public Sub Main()
Data_Enter
Build_pop
Reproduction
End Sub
```

---

```
Public Sub Data_Enter()
Worksheets("Sheet1").Select
num_periods = 1
num_CP = 4
num_states = 3

'phase plan enter
State(1, 1) = 1: State(1, 2) = 0: State(1, 3) = 0: State(1, 4) = 0
State(2, 1) = 0: State(2, 2) = 1: State(2, 3) = 1: State(2, 4) = 0
State(3, 1) = 0: State(3, 2) = 0: State(3, 3) = 1: State(3, 4) = 1

For a = 1 To num_periods
period(a) = Cells(6, a + 1)
Next a

For b = 1 To num_CP
For c = 1 To num_periods
Arr_rate(b, c) = Cells(b + 1, c + 1)
Next c
Next b
```

```

For d = 1 To num_CP
For e = 1 To num_periods
m = 1
TArriv(d, e, m) = 0
Randomize
Do
m = m + 1
XX = Rnd
TArriv(d, e, m) = TArriv(d, e, m - 1) + 1 + ((1 / Arr_rate(d, e)) * (Log(1 / (1 - XX))))
'Cells(m, 9) = TArriv(4, 1, m) 'ver
Loop Until TArriv(d, e, m) >= period(e) + 1
num_arrived(d, e) = m
Next e
Next d

For f = 1 To num_CP
For g = 1 To num_periods
inter_delay(f, g) = Cells(f + 15, g + 1)
Next g
Next f

For h = 1 To num_periods
CTmax(h) = Cells(8, h + 1)
CTmin(h) = Cells(7, h + 1)
Next h

pop_size = 50
num_generations = 3000
xover_p = 0.95
mut_p = 0.3

End Sub

```

---

```

Public Sub Build_pop()
Worksheets("Sheet2").Select
For chrom = 1 To pop_size
chromosome (chrom)
Label(chrom) = chrom
Next chrom
Cells(10, 10) = YFit(10)
Generation_Sort
End Sub

```

---

```

Public Sub chromosome(ch)
Dim x(10)
Dim randomvalue As Integer
For i = 1 To num_periods
Randomize
sum = 0
For j = 1 To num_states
'randomvalue = CInt(Int((20 - 10) * Rnd() + 10)) 'added to guarantee the state timing will be large enough
'x(j) = randomvalue / 20
x(j) = Rnd
If x(3) > 0.2 Then 'to ensure a realistic timing for state C
x(3) = 0.2
End If
sum = sum + x(j)
Next j
For k = 1 To num_states
prop(k, i, ch) = x(k) / sum
proportion(k, i) = prop(k, i, ch)
Next k
y = Rnd
CT(i, ch) = CTmin(i) + (CTmax(i) - CTmin(i)) * y
CTq(i) = CT(i, ch)
Next i

For l = 1 To num_periods
For m = 1 To num_CP
CP = m
Queuing (l)
GetMaxQL (l)
QLmax(m, l, ch) = QL_max
QLav(m, l, ch) = QL_av
GetMaxQW (l)
QWmax(m, l, ch) = QW_max
QWav(m, l, ch) = QW_av
Next m
Next l

```

```

GetMax_GenQL (ch)
Gener_QL(ch) = Gen_QL
GetMax_GenQW (ch)
Gener_QW(ch) = Gen_QW
YFit(ch) = Gen_QL * Gen_QW
End Sub

```

---

```

Public Sub Queuing(q)
n = 1 'cars
p = 1 'multiples of interdelay
num_cyc = 1 ' number of cycles
Dim val1, val2, val3, val4, val5, val6, val7, val8

If CP = 1 Then
Do
'Cells(n, 10) = TArriv(1, q, n) 'ver
Tstartgreen = (num_cyc - 1) * CTq(q)
Tendgreen = Tstartgreen + (proportion(1, q) * CTq(q))
If TArriv(1, q, n) < Tendgreen Then
val1 = Tstartgreen + (p - 1) * inter_delay(1, q)
val2 = TArriv(1, q, n)
If val1 >= val2 Then
Tdep(1, q, n) = val1
Else: Tdep(1, q, n) = val2
End If
'Cells(n, 11) = Tdep(1, q, n) 'ver
n = n + 1
p = p + 1
Else: num_cyc = num_cyc + 1
p = 1
End If
Loop Until n = num_arrived(1, q) + 1

ElseIf CP = 2 Then
Do
'Cells(n, 13) = TArriv(2, q, n) 'ver
Tstartgreen = ((num_cyc - 1) * CTq(q)) + (proportion(1, q) * CTq(q))
Tendgreen = Tstartgreen + (proportion(2, q) * CTq(q))
If TArriv(2, q, n) < Tendgreen Then
val3 = Tstartgreen + (p - 1) * inter_delay(2, q)
val4 = TArriv(2, q, n)
If val3 >= val4 Then
Tdep(2, q, n) = val3
Else: Tdep(2, q, n) = val4
End If
'Cells(n, 14) = Tdep(2, q, n) 'verification
n = n + 1
p = p + 1
Else: num_cyc = num_cyc + 1
p = 1
End If
Loop Until n = num_arrived(2, q) + 1

ElseIf CP = 3 Then
Do
'Cells(n, 16) = TArriv(3, q, n) 'ver
Tstartgreen = ((num_cyc - 1) * CTq(q)) + (proportion(1, q) * CTq(q))
Tendgreen = Tstartgreen + ((proportion(2, q) + proportion(3, q)) * CTq(q))
If TArriv(3, q, n) < Tendgreen Then
val5 = Tstartgreen + (p - 1) * inter_delay(3, q)
val6 = TArriv(3, q, n)
If val5 >= val6 Then
Tdep(3, q, n) = val5
Else: Tdep(3, q, n) = val6
End If
'Cells(n, 17) = Tdep(3, q, n)
n = n + 1
p = p + 1
Else: num_cyc = num_cyc + 1
p = 1
End If
Loop Until n = num_arrived(3, q) + 1

```

```

Else 'CP=4
Do
'Cells(n, 19) = TArriv(4, q, n) 'ver
Tstartgreen = ((num_cyc - 1) * CTq(q)) + ((proportion(1, q) + proportion(2, q)) * CTq(q))
Tendgreen = Tstartgreen + (proportion(3, q) * CTq(q))
If TArriv(4, q, n) < Tendgreen Then
val7 = Tstartgreen + (p - 1) * inter_delay(4, q)
val8 = TArriv(4, q, n)
If val7 >= val8 Then
Tdep(4, q, n) = val7
Else: Tdep(4, q, n) = val8
End If
'Cells(n, 20) = Tdep(4, q, n) 'ver
n = n + 1
p = p + 1
Else: num_cyc = num_cyc + 1
p = 1
End If
Loop Until n = num_arrived(4, q) + 1

End If
End Sub

```

---

```

Public Sub GetMaxQW(s)
sumQW = 0
Wmax = 0
QW = 0
t = 1
If CP = 1 Then
Do
QW = Tdep(CP, s, t) - TArriv(CP, s, t)
'Cells(t, 12) = QW
If QW > Wmax Then
Wmax = QW
End If
t = t + 1
sumQW = sumQW + QW
Loop Until t = num_arrived(CP, s)
QW_max = Wmax
QW_av = sumQW / t

Else 'CP=2
Do
QW = Tdep(CP, s, t) - TArriv(CP, s, t)
'Cells(t, 15) = QW
If QW > Wmax Then
Wmax = QW
End If
t = t + 1
sumQW = sumQW + QW
Loop Until t = num_arrived(CP, s)
QW_max = Wmax
QW_av = sumQW / t
End If
End Sub

```

---

```

Public Sub GetMax_GenQL(chr) 'max queue length in a chromosome
Dim GenQL(10)
Dim tempoval

For u = 1 To num_CP
GenQL(u) = QLmax(u, 1, chr)
Next u

'must do bubble sorting
For uu = 1 To num_CP - 1
tempoval = GenQL(uu)
For uuu = 1 To num_CP - uu
If GenQL(uuu + uu) > tempoval Then
GenQL(uu) = GenQL(uuu + uu)
GenQL(uuu + uu) = tempoval
tempoval = GenQL(uu)
End If
Next uuu
Next uu
Gen_QL = GenQL(1)
End Sub

```

---

```

Public Sub GetMax_GenQW(cch)
Dim GenQW(10)
Dim temporval
For u = 1 To num_CP
GenQW(u) = QWmax(u, 1, cch)
Next u

For uu = 1 To num_CP
temporval = GenQW(uu)
  For uuu = 1 To num_CP - uu
  If GenQW(uuu + uu) > temporval Then
  GenQW(uu) = GenQW(uuu + uu)
  GenQW(uuu + uu) = temporval
  temporval = GenQW(uu)
  End If
  Next uuu
Next uu
Gen_QW = GenQW(1)
End Sub

Public Sub Generation_Sort()
Worksheets("Sheet2").Select
Dim normfit(100) As Single

For v = 1 To (pop_size - 1)
tempval = YFit(v)
tempindex = Label(v)
  For w = 1 To (pop_size - v)
  If YFit(w + v) < tempval Then
  YFit(v) = YFit(w + v)
  Label(v) = Label(w + v)
  YFit(w + v) = tempval
  Label(w + v) = tempindex
  tempval = YFit(v)
  tempindex = Label(v)
  End If
  Next w
Next v

For x = 1 To pop_size
Cells(x, 2) = Label(x)
Cells(x, 3) = YFit(x)
Next x

Cells(1, 1) = 0
sum1 = 0
For x = 1 To pop_size
sum1 = sum1 + YFit(x)
Next x
sumfit = sum1

For y = 1 To pop_size
normfit(y) = YFit(y) / sumfit
Next y

sum2 = 0

For Z = 1 To pop_size
sum2 = sum2 + normfit(Z)
Cells(Z + 1, 1) = sum2
Next Z

myrange = Range("A1:B50")
For aa = 1 To 2
bb = Rnd
candidate(aa) = Application.WorksheetFunction.VLookup(bb, myrange, 2, True)
Next aa

End Sub

```

---

```

Public Sub Reproduction()
Worksheets("Sheet2").Select
Dim optem(2)
Dim worst(2)
Dim eks(6, 6)
Dim randomval As Integer

For gen = 1 To num_generations
Cells(1, 4) = gen
If candidate(1) <> candidate(2) Then

Randomize
yy = Rnd

If yy <= xover_p Then
optem(1) = candidate(1)
optem(2) = candidate(2)
worst(1) = Label(pop_size - 1)
worst(2) = Label(pop_size)

For bb = 1 To 2
Randomize
yy = Rnd
If yy <= 0.5 Then
CT(1, worst(bb)) = CT(1, optem(bb))
CTq(1) = CT(1, worst(bb))
Else
If bb = 1 Then xch = 2 Else xch = 1
CT(1, worst(bb)) = CT(1, optem(xch))
CTq(1) = CT(1, worst(bb))
End If

Randomize
For st = 1 To num_states
zz = Rnd
If zz <= 0.5 Then
eks(st, 1) = prop(st, 1, optem(bb))
Else
If bb = 1 Then xc = 2 Else xc = 1
eks(st, 1) = prop(st, 1, optem(xc))
End If
Next st

Randomize
mut1 = Rnd
If mut <= mut_p Then
cc = Rnd
CT(1, worst(bb)) = CTmin(1) + (CTmax(1) - CTmin(1)) * cc
CTq(1) = CT(1, worst(bb))
End If
Randomize
For st = 1 To num_states
mut2 = Rnd
If mut2 <= mut_p Then
randomval = CInt(Int((20 - 10) * Rnd() + 10))
dd = randomval / 20
eks(st, 1) = dd
End If
Next st

```

```

If prop(3, 1, worst(bb)) > 0.2 Then 'TO ASSURE REASONABLE LIMIT FOR STATE C
eks(3, 1) = 0.2
Total = 0
For tt = 1 To num_states
Total = Total + eks(tt, 1)
Next tt
For ttt = 1 To num_states
prop(ttt, 1, worst(bb)) = eks(tt, 1) / Total
proportion(ttt, 1) = prop(ttt, 1, worst(bb))
Next ttt
ElseIf prop(3, 1, worst(bb)) < 0.15 Then 'TO ASSURE REASONABLE LIMIT FOR STATE C
eks(3, 1) = 0.2
Total2 = 0
For tt = 1 To num_states
Total2 = Total2 + eks(tt, 1)
Next tt
For ttt = 1 To num_states
prop(ttt, 1, worst(bb)) = eks(tt, 1) / Total2
proportion(ttt, 1) = prop(ttt, 1, worst(bb))
Next ttt
Else: sum = 0
For ee = 1 To num_states
sum = sum + eks(ee, 1)
Next ee
For ff = 1 To num_states
prop(ff, 1, worst(bb)) = eks(ff, 1) / sum
proportion(ff, 1) = prop(ff, 1, worst(bb))
Next ff
End If

For gg = 1 To num_CP
CP = gg
Queuing (1)
GetMaxQL (1)
QLmax(gg, 1, worst(bb)) = QL_max
QLav(gg, 1, worst(bb)) = QL_av
GetMaxQW (1)
QWmax(gg, 1, worst(bb)) = QW_max
QWav(gg, 1, worst(bb)) = QW_av
Next gg

GetMax_GenQL (worst(bb))
Gener_QL(worst(bb)) = Gen_QL
GetMax_GenQW (worst(bb))
Gener_QW(worst(bb)) = Gen_QW
YFit(pop_size - 2 + bb) = Gen_QL * Gen_QW

Next bb
Generation_Sort

End If
End If

'COPYING (if yy > xover, or candidate 1 equals to 2)

optem(1) = candidate(1)
optem(2) = candidate(2)
worst(1) = Label(pop_size - 1)
worst(2) = Label(pop_size)

```



```

For hh = 1 To 2
CT(1, worst(hh)) = CT(1, optem(hh))
CTq(1) = CT(1, worst(hh))
For ii = 1 To num_states
prop(ii, 1, worst(hh)) = prop(ii, 1, optem(hh))
proportion(ii, 1) = prop(ii, 1, worst(hh))
Next ii

For jj = 1 To num_CP
CP = jj
Queuing (1)
GetMaxQL (1)
QLmax(jj, 1, worst(hh)) = QL_max
QLav(jj, 1, worst(hh)) = QL_av
GetMaxQW (1)
QWmax(jj, 1, worst(hh)) = QW_max
QWav(jj, 1, worst(hh)) = QW_av
Next jj

GetMax_GenQL (worst(hh))
Gener_QL(worst(hh)) = Gen_QL
GetMax_GenQW (worst(hh))
Gener_QW(worst(hh)) = Gen_QW
YFit(pop_size - 2 + hh) = Gen_QL * Gen_QW

Next hh
Cells(gen + 5, 6) = gen 'FOR PLOTTING
bestingen = Cells(1, 2)
Cells(gen + 5, 5) = bestingen
Cells(gen + 5, 7) = prop(1, 1, bestingen) * CT(1, bestingen)
Generation_Sort







Cells(1, 5) = Label(1)
Cells(2, 5) = YFit(1)





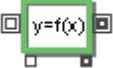
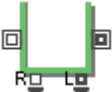

Next gen

Worksheets("Sheet3").Select
For jj = 1 To 2
Cells(jj + 1, 1) = Label(jj)
Cells(jj + 1, 2) = CT(1, Label(jj))
Cells(jj + 1, 3) = prop(1, 1, Label(jj))
Cells(jj + 1, 4) = prop(2, 1, Label(jj))
Cells(jj + 1, 5) = prop(3, 1, Label(jj))
Cells(jj + 1, 9) = YFit(Label(jj))
Cells(jj + 1, 10) = QLmax(1, 1, Label(jj))
Cells(jj + 1, 11) = QLav(1, 1, Label(jj))
Cells(jj + 1, 12) = QLmax(2, 1, Label(jj))
Cells(jj + 1, 13) = QLav(2, 1, Label(jj))
Cells(jj + 1, 14) = QLmax(3, 1, Label(jj))
Cells(jj + 1, 15) = QLav(3, 1, Label(jj))
Cells(jj + 1, 16) = QLmax(4, 1, Label(jj))
Cells(jj + 1, 17) = QLav(4, 1, Label(jj))
Cells(jj + 1, 18) = QWmax(1, 1, Label(jj))
Cells(jj + 1, 19) = QWav(1, 1, Label(jj))
Cells(jj + 1, 20) = QWmax(2, 1, Label(jj))
Cells(jj + 1, 21) = QWav(2, 1, Label(jj))
Cells(jj + 1, 22) = QWmax(3, 1, Label(jj))
Cells(jj + 1, 23) = QWav(3, 1, Label(jj))
Cells(jj + 1, 24) = QWmax(4, 1, Label(jj))
Cells(jj + 1, 25) = QWav(4, 1, Label(jj))
Next jj
End Sub

```

## APPENDIX (B): EXTENDSIM8 BLOCKS AND LIBRARIES

Block	Function
<b>Lookup Table</b> 	Acts as a lookup table (x in and y out) that are used to calculate what the output value would be for the given input. Input values can come from an input connector (the default) or can be simulation time. The output can be discrete, interpolated or stepped.
<b>Optimizer</b> 	Searches for the best set of model parameters that maximizes profit or minimizes cost, given parameter limits and any entered constraints. Uses evolutionary strategies that are similar to genetic algorithms.
<b>Mean &amp; Variance</b> 	Calculates the mean, variance, and standard deviation of the values input during the simulation.
<b>Information</b> 	Reports statistics about the items that pass through it, such as cycle time and TBI (Time Between Items).
<b>Equation(I)</b> 	Calculates equations when an item passes through. The equations can use multiple inputs and properties of the item as variables, and the result(s) of the equations can be assigned to multiple outputs and properties of the item.
<b>Queue</b> 	Queues items and releases them based on a user selected queuing algorithm, such as Resource pool queue, Attribute value, First in first out, Last in first out, and Priority. Options include renegeing and setting wait time. If you need more advanced control over the queuing algorithm, consider using the Queue Equation block, below.
<b>Create</b> 	Provides items or values for a discrete event simulation at specified interarrival times. Choose either a distribution or a schedule for the arrival of items or values into the model.
<b>Exit</b> 	Passes items out of the simulation. The total number of items absorbed by this block is reported in its dialog and at the value output connectors.

Block	Function
<p><b>Gate</b></p> 	<p>Limits the passing of items through a portion of the model, either by demand or by using a sensor connector to monitor how many items are in a section of the model.</p>
<p><b>Select Item In</b></p> 	<p>Selects items from one input to be output based on a decision.</p>
<p><b>Select Item Out</b></p> 	<p>Selects which output gets items from the input, based on a decision</p>
<p><b>Executive</b></p> 	<p>This block must be placed to the left of all other blocks in discrete event and discrete rate models. It does event scheduling and provides for simulation control, item allocation, attribute management, and other discrete event and discrete rate model settings.</p>
<p><b>Decision</b></p> 	<p>Makes a decision and outputs TRUE or FALSE values based on the inputs and defined logic. The dialog lets you perform the following tests comparing A to B: greater than, greater than or equal to, equal to, less than, less than or equal to, and not equal. You can also test for A being an invalid number (noValue). The block can be set to use hysteresis.</p>
<p><b>Equation</b></p> 	<p>Outputs the results of the equations entered in the dialog. You can use ExtendSim's built-in operators, functions, and some or all of the input values as part of the equation. The equations can have any number of inputs and any number of outputs.</p>
<p><b>Max &amp; Min</b></p> 	<p>Determines the maximum and minimum values from among the values input. The dialog shows the maximum and minimum values and the input connectors they came from. The block outputs the maximum or minimum values and the respective connector number.</p>

## APPENDIX (C): DATA COLLECTION POINTS AND OBSERVATIONS

Inter-arrivals for 7-9 am										
intersection 1				intersection 2						
1'		2'		1			2		3	4
A	D	A	D	A		D	A	D	D	
0	0	0	0	0.26	0.26	47.68	0	0	0	0
49.51	1.79	0.25	1.8	0.28	0.28	0.99	13.17	2.07	11.03	8.6
1.95	4.41	2.17	2.05	0.31	0.31	0.9	2.17	6.76	1.57	1.96
2.92	4.37	0.95	2.64	0.32	0.32	1.21	1.95	1.92	1.37	4.02
4.85	5.33	2.99	2.26	0.34	0.34	0.84	7.57	26.43	4.83	8.15
5.73	17.81	1.03	1.93	0.34	0.34	1.85	3.97	0.84	25.95	6.43
2.37	2.32	1.22	1.33	0.34	0.34	0.58	3.62	1.24	1.56	10.57
6.87	4.67	1.09	2.79	0.35	0.35	2.39	0.91	72.47	1.19	5.57
15.43	3.22	0.99	7.95	0.37	0.37	2.12	2.64	3.15	2.62	0.55
3.03	4.06	4.34	9.86	0.37	0.37	0.59	4.84	1.62	1.02	75.73
0.92	3.06	2.37	2.75	0.38	0.38	1.81	4.54	3.67	0.24	3.83
5.13	64.25	10.44	0.24	0.39	0.39	1.53	3.47	0.59	79	6.61
2.44	2.25	43.31	1.89	0.39	0.39	1.22	5.3	5.57	4.79	3.09
5.04	3.53	0.26	1.27	0.4	0.4	4.46	2.36	5	0.74	13.99
3.67	3.04	1.26	1.41	0.41	0.41	1.19	5.62	1.11	1.08	3.41
32	3.01	0.91	0.5	0.41	0.41	1.68	1.57	2	0.72	8.53
30.5	2.63	2.03	0.53	0.42	0.42	2.34	2.41	6.97	2.36	5.59
1.76	4.65	1.06	0.73	0.42	0.42	1.57	0.71	95.76	8.3	3.93
1.13	2.28	1.23	0.81	0.43	0.43	0.99	0.97	1.75	7.13	66.47
1.4	1.75	0.24	0.89	0.45	0.45	0.92	2.54	1.52	6.67	16.41
4.31	6.36	2.26	1.73	0.46	0.46	2	1.53	1.04	1.25	11.04
2.13	2.53	1.09	0.56	0.46	0.46	2.08	0.76	5.84	6.07	3.29
1.66	0.35	1.74	0.79	0.46	0.46	0.53	1.54	2.43	3.83	5.98
1.24	1.3	3.52	2.95	0.47	0.47	1.18	1.17	2.83	1.45	5.75
4.32	2.26	0.79	4.3	0.48	0.48	0.59	1.62	2.61	5.79	3.16
1.27	1.25	0.52	2.53	0.5	0.5	0.65	4.14	1.36	1.45	3.84
3.86	2.23	3.11	1.81	0.51	0.51	0.69	0.73	2.24	1.64	1.14
1.04	2.07	1.16	58.13	0.52	0.52	3.01	2.13	2.93	71.7	2.54
5.4	1.54	2.72	6.75	0.53	0.53	1.21	2.51	35.95	4.54	0.55
0.31	2.93	2.15	3.24	0.53	0.53	2.51	1.15	81.88	7.71	6.88
2.39	1.07	0.51	8.83	0.53	0.53	1.39	1.4	0.47	12.45	59.28
1.59	53.42	2.23	3.3	0.54	0.54	4.19	5.66	0.7	12.34	5.25
1.54	2.57	6.42	1.01	0.55	0.55	1.49	3.93	1.59	2.75	6.76

Inter-arrivals for 9-1 pm										
intersection 1				intersection 2						
1'		2'		1			2		3	4
A	D	A	D	A		D	A	D	D	
0	0	0	0	0	0	0	0	0	0	1.09
20.18	0.82	6.15	3.06	2.15	62.74	1.77	0.56	5.41	1.12	2.37
1.77	1.24	2.71	5.87	1.65	6.37	0.93	2.24	1.47	1.29	4.67
12.11	0.89	2.15	2.21	2.44	4.25	1.19	8.55	3.63	1.93	2.23
4.6	1.29	4.37	6.36	5.55	1.53	0.48	1.3	20.63	1.55	5.92
5.1	2.84	0.39	3.83	1.98	1.38	0.46	1.02	87.58	1.66	2.63
7.67	1.38	1.72	7.59	1.38	17.45	0.5	1.04	3.59	5.45	2.59
11.37	1.56	3.02	76.69	3.72	25.34	0.53	1.93	2.1	3.18	72.19
4.6	1.53	1.33	1.52	8.41	13.43	0.58	4.39	2.1	6.36	7.72
1.18	1.68	9.51	3.45	18.01	13.06	1.3	31.54	2.28	2.58	4.21
0.87	3.06	1.8	20.87	15.28	2.42	0.44	1.7	15.81	10.33	3.19
7.05	1.94	27.13	6.8	13.22	4.47	1.35	3.45	2.07	2.41	7.08
4.58	6.69	13.47	2.74	1.2	5.31	0.38	2.65	1.82	4.9	2.84
13.53	10.43	0.33	81.12	1.2	7.3	0.65	1.37	9.19	1.21	4.96
3.9	14.84	0.38	1.55	2.05	2.29	1.33	2.27	80.33	6.58	10.46
4.43	55.37	3.55	4.44	2.32	2.6	0.56	0.29	1.74	79.35	0.72
4.75	1.08	0.44	36.78	0.22	5.43	1.67	0.92	6.78	1.35	1.6
2.02	4.48	4.79	17.24	1.48	41.88	0.44	0.76	4.58	0.96	1.43
3.59	3.44	1.61	1.29	0.71	2.73	1.72	1.74	30.66	4.53	82.21
2.94	3.57	0.92	0.82	0.79	21.6	4.29	1.04	1.6	4.06	1.85
11.2	3.55	0.77	0.81	6.19	19.62	1.61	1.61	1.99	1.91	1.4
4.89	7.23	1.74	0.46	1.14	1.74	0.48	6.34	1.4	2.96	2.05
2.54	15.22	0.99	0.25	3.33	3.28	1.28	1.97	1.81	2.46	6.68
1.87	3.91	0.45	0.57	2.44	3.52	0.72	1.26	2.33	4.74	9.03
3.62	0.64	5.77	0.4	7.3	25.26	1.86	1.45	0.87	1.87	6.69
1.44	0.97	2.18	0.25	0.86	2.95	0.63	1.06	6.52	0.85	4.47
5.31	4.07	2.95	1.03	3.08	1.65	1.01	1.76	2.2	2.51	47.81
3.25	3.69	1.5	0.63	5.83	3.23	0.6	0.49	1.89	5.41	1.62
3.41	60.09	0.87	1.9	1.06	1.61	2.45	1.44	2.56	40.86	4.79
2.29	2.12	1.07	0.37	1.16	4.3	1.66	4.11	2.97	34.19	1.67
1.11	1.35	0.73	0.98	3.15	5.25	2.65	7.24	0.57	0.39	17.01
5.46	1.03	4.95	1.83	5.85	1.51	9.66	34.36	0.48	2.22	3.3
8.11	0.99	2.45	0.89	1.39	2.3	2.11	7.61	2.05	1.83	8.39

Inter-arrivals for 1- 5 pm										
intersection 1				intersection 2						
1'		2'		1		2		3	4	
A	D	A	D	A	D	A	D	D		
2.16	2.15	0.65	1.9	4.13	0.14	4.71	0.88	1.16	22.75	2.79
0.47	0.55	0.52	2.91	2.54	0.18	3.5	3.06	1.51	5.28	2.37
1.03	2.96	0.5	5.51	0.54	0.19	0.41	5.54	5.4	5.22	5.38
2.85	0.45	1.45	2.35	7.48	0.2	7.5	2.92	2.18	0.98	1.92
1.13	0.43	1.85	2.32	1	0.21	0.81	9.92	61.13	32.75	1.4
0.59	3.98	0.69	2.06	28.86	0.21	0.37	1.49	1.33	3.91	2.6
1.46	0.55	0.98	1.69	5.75	0.22	1.79	4.57	0.83	20.89	29.01
1.85	2.49	2.11	0.82	3.49	0.22	0.64	3.44	1.02	1.12	2.38
2.04	0.75	0.68	1.3	2.52	0.23	0.94	14.6	1.39	1.22	2.41
4.46	2.14	0.47	0.74	1.97	0.23	2.19	2.8	1.34	2.73	4.09
1.1	0.81	1.97	1.57	11.56	0.24	1.35	18.3	2.41	1.84	2.09
2.37	5.64	0.81	0.86	1.66	0.24	0.76	3.66	12.25	2.37	2.57
0.84	0.81	0.87	0.83	1.84	0.24	0.34	1.98	1.9	1.88	6.96
12.38	2.22	0.55	1.09	19.69	0.24	2.83	9.62	19.87	93.26	5.74
0.84	1.5	4.49	0.92	0.93	0.25	2.94	2.31	4.49	6.17	5.31
0.61	60.77	2.51	0.95	2.55	0.27	0.54	1.93	5.35	2.34	3.59
4.64	0.97	4.95	0.78	4.51	0.28	1.44	1.19	0.93	4.79	90.9
1.14	1.22	5.66	0.69	1.99	0.28	1	3.62	1.08	1.49	2.02
3.69	2.43	0.55	0.65	1.24	0.29	0.32	1.99	2.64	1.42	0.56
0.54	0.37	0.52	0.5	19.63	0.3	3.24	2.51	1.56	87.97	19.57
0.67	3.14	2.46	0.78	9.63	0.3	0.41	5.53	1.01	6.47	1.41
0.8	1.43	2.57	0.5	3.9	0.33	1.31	2.24	4.21	8.84	1.52
0.67	12.16	1.4	0.41	18.55	0.34	0.91	3.52	8.89	6.27	5.2
1.37	0.25	2.1	1.09	2.62	0.34	0.78	0.61	1.05	2.8	1.34
1.06	0.68	0.82	0.63	1.31	0.34	2.45	14.19	1.3	1.49	0.58
1.44	0.27	0.49	0.57	3.11	0.35	1.14	4.34	1.91	2.7	1.87
2.36	1.15	1.77	0.72	3.74	0.35	2.26	6.66	60.06	7.57	1.42
0.72	2.32	4.71	2.4	2.19	0.36	0.34	1.31	1.3	2.7	81.22
5.7	4.88	8.52	0.92	2.37	0.37	0.42	2.13	1.98	3.52	3.55
1.44	0.25	13.9	0.73	4.82	0.37	2.17	4.43	1.17	12.76	0.88
2.71	0.36	1.51	25.44	4.39	0.38	1.31	0.82	1.51	7.36	1.78
8.75	1.64	20.8	30.41	9.12	0.39	0.31	5.74	1.03	1.42	1.54
1.17	1.63	2.96	0.82	0.85	0.4	52.78	9.27	1.08	14.96	1.62
6.38	0.3	1.3	0.53	1.07	0.41	9.71	5.95	0.91	13.86	3.65
1.27	6.43	0.9	0.57	1.52	0.42	0.41	10.83	1.29	9.76	2.07
3.35	0.32	0.76	0.78	0.52	0.44	9.55	16.5	5.17	119.02	2.19
1.01	6.36	2.14	2.65	37.72	0.45	1.81	2.37	74.14	36.68	0.41

Inter-arrivals for 5-11pm										
intersection 1				intersection 2						
1'		2'		1			2		3	4
A	D	A	D	A		D	A	D	D	
2.46	101.71	0.93	0.79	1.08	4.27	1.02	3.19	1.53	2.87	20.74
7.4	6.69	0.35	0.68	1.34	1.99	2.23	36.63	5.92	3.04	40.16
2.77	7.04	0.27	0.53	1.79	2.8	2.7	15.25	3.65	5.38	1.19
20.4	4.25	0.58	0.55	2.97	15.8	7.88	0.87	1.23	7.04	4.91
1.56	2.26	0.41	0.7	1.07	2.41	1.91	8.74	2.09	6.1	6.24
1.57	0.45	2.19	0.43	0.79	6.11	4.11	1.94	0.38	4.25	5.77
3.94	0.27	1.88	0.62	1.13	2.03	0.47	1.53	1.04	5.99	2.09
4	0.21	0.47	0.89	1.19	8.65	1.31	2.1	1.52	8.09	17.49
1.15	0.22	0.67	0.69	0.7	1.63	1.44	2.52	3.27	3.4	0.46
2.23	4.36	0.95	1.25	1.44	3.4	1.64	1.61	5.84	83.79	4.72
9.04	3.91	0.49	0.5	2.04	5.71	1.36	10.13	9.86	3.85	3.96
16.08	2.31	5.5	0.54	1.28	3.29	1.53	2.92	3.19	9.23	2.36
41.18	1.35	43.61	0.84	2.08	2.17	1.81	3.23	75.86	8.23	3.23
4.07	11.1	1.59	1.35	2.25	4.05	1.48	2.37	2.31	3.26	64.78
4.83	2.54	1.99	0.93	1.77	2.78	0.97	1.4	1.59	3.92	14.23
2.76	1.65	2.58	0.69	1.91	10.69	3.35	1.24	1.56	11.12	7.92
2.86	60.01	2.09	0.98	1.68	1.02	4.27	1.85	1.78	73.3	15.55
4.33	2.24	2.03	1.19	2.43	0.4	1.85	3.57	2.73	3.14	1.37
0.84	16.37	0.99	1.08	2.42	0.92	1.69	0.74	0.3	2.19	1.98
8.89	23.11	1.18	23.32	0.6	8.35	1.82	1.14	1.77	27.93	8.17
0.97	3.72	3.59	0.79	6.34	10.3	2.7	1.65	0.42	2.99	72.56
1.94	4.72	11.3	1.38	1.3	23.99	2.01	4.29	1.75	6.87	3.09
8.67	40.28	0.37	1.26	0.66	3.67	1.23	2.78	2.61	58.49	4.23
6.58	4.25	1.27	2.59	0.85	1.95	0.38	0.41	0.37	1.49	7.17
11.03	2.75	3.39	4.17	2.34	1.98	1.51	3.16	2.17	0.44	59.68
2.61	2.19	4.74	2.61	1.51	10.83	0.77	0.72	3.8	1.59	4.53
4.33	4.41	0.41	56.99	1.41	2.04	1.85	0.76	1.83	2.06	2.13
2.79	4.81	7.76	0.77	2.46	1.6	0.58	2.13	10.22	1.68	3.94
2.9	3.98	1.21	2.01	1.24	1.46	1.22	1.1	89.03	2.13	66.58
49.31	5.8	2.05	0.42	1	57.85	1.14	3.44	9.76	1.15	0.77
22.72	6.06	0.31	0.6	0.92	5.77	1.08	1.06	0.88	8.72	2.63
0.54	3.02	1.24	0.66	5.11	2.79	2.76	8.91	3.77	8.08	2.85